

VON DUPRIN®

33A/35A™ Series
Exit Devices



IR Ingersoll Rand
Security Technologies

Introduction

The proper selection and application of exit hardware, in addition to safety, are major concerns to all responsible manufacturers. Exit devices are a critical part of a door opening or access system and will provide safe and reliable service when properly applied and maintained. It is the policy of Von Duprin to design and manufacture exit devices to a high standard of quality and reliability in accordance with accepted U.S. domestic and international standards.

It is intended that the information included in this publication, when properly used, will provide clear and reliable guidelines to the proper general selection and application. However, the scope of the information is necessarily limited.

Von Duprin pushpad exit devices are available in two external surface styles, designated 33A Series and 35A Series. The two styles are mechanically and dimensionally identical and provide a wide selection of appearance options.



33A Series features grooved mechanism case.



35A Series features smooth mechanism case.

Deadlocking Latchbolt

Deadlocking latchbolt prevents forced latchbolt retraction providing higher security for your openings.



Latch Bolt
(33A Rim device shown)

The Quiet One®

A fluid damper decelerates the pushpad on its return stroke and eliminates most noise associated with exit device operations. Furnished on all 33A/35A Series exit devices.

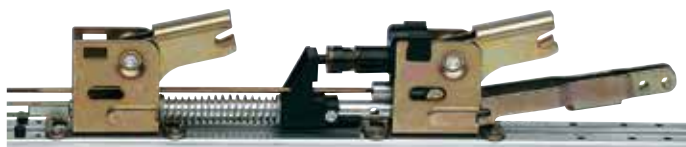

Be sure to ask your SSC representative to tell you about **Custom Solutions** by Ingersoll Rand Security Technologies. To learn more visit securitytechnologies.ingersollrand.com.



QuietSolutions



CustomDécor



HighSecurity and Safety



EnvironmentalSolutions



FlexibleConfigurations

Table of Contents

	Exit Hardware	 Fire Exit Hardware
Rim Devices	33A/35A..... 8	
	Trim..... 9	
Surface Mounted Vertical Rod Devices	3327A/3527A 10	3327A-F/3527A-F 12
	Trim..... 11	Trim..... 13
Concealed Vertical Rod Devices	3347A/3547A 14	3347A-F/3547A-F 16
	Trim..... 15	Trim..... 17
	3348A/3548A 18	3348A-F/3548A-F 20
	Trim..... 19	Trim..... 21
	3349A/3549A 22	3349A-F/3549A-F 24
	Trim..... 23	Trim..... 25

Options & Accessories

Applications & Trim Operation	Trim Selection Optional Trim
Additional Information	ANSI Grade, Type & Function Device Dimensions Finishes Fire Label Ratings/Applications Handing How-To-Order Information Nomenclature Popular Double Door Applications Minimum Stile Information
Trim Options	Optional Levers Optional Trim Trim Selection Operation Options
Strike Options	Optional Strikes

Electrical Options	ALK Exit Alarm kit RX Request to Exit WP-RX Request to Exit E-Trim LX Latch Bolt Monitoring EL Electric Latch Retraction QEL Electric Latch Retraction SS Signal Switch PN Pneumatic LBR/LBL Less Bottom Rod/Latch PL Pullman Latch RG-27 Vertical Rod and Latch Guard Dummy Pushpad CD Cylinder Dogging CDK, HDK Cylinder Dogging and Hex Key Dogging Kits GBK Glass Bead Kit Cylinders
Electrical Accessories	Power Supplies PS902 PS914 EPT Electric Power Transfer

Rim devices, specify:

1. Exit device model number with trim selection. Examples: 33A-EO (exit only with no outside trim). 33A-NL (includes 386NL trim). 33A-NL-OP (includes the 388 trim less pull).
2. Size 4' (1219mm) for door sizes 2' 10" (940mm) to 4' (1219mm). Size 3' (914mm) for door sizes 2' 4" (792mm) to 3' (914mm) is shipped standard.
3. Door thickness if other than 1¾" (44mm).
4. Door and frame material if other than aluminum.
5. Finish, see page 38.
6. Handing required on "L", "SS", or "386NL". Specify LHR or RHR. See page 7.

Vertical rod devices, specify:

1. Exit device model number with trim selection. Examples: 3327A-EO (exit only with no outside trim.) 3327A-TL-OP (includes 360T Control) 3327A-TL (includes 374T and 386DT).
2. Size 2' (1219mm) for door sizes 2' (610mm). Size 3' (914mm) for door sizes 2' 2" (792mm) to 3' (914mm) is shipped standard. Size 4' (1219mm) for door sizes 2' 8" (940mm) to 4' (1219mm).
3. Door thickness if other than 1¾" (44mm).
4. Door height if greater than 7' (2134mm) surface vertical rod device (8' 4" for concealed devices) or extension rods will be supplied.
5. Door and frame material if other than aluminum or hollow metal.
6. Finish, see page 38.
7. Handing required on "L", "SS", or "386NL". Specify LHR or RHR. See page 7.

Pullman latches are optional for 3327A/3527A and 3347A/3547A devices. Latchbolts remain extended at all times. Specify "Pullman Latch" when required.

Device Trim, Cross-Reference*:

33/35 Devices	Status	33A/35A Devices
333NL-TP	Replaced	386NL
333DT	Replaced	386DT
337NL-TP	Replaced	386NL
337DT	Replaced	386DT
334	Replaced	388
334 x 550	Replaced	388 x 550
370L	Replaced	360L
370T	Replaced	360T
372L	Replaced	360L
374T x 333DT	Replaced	374T x 386DT
—	New	374T x 392-6
376T x 337DT	Replaced	376T x 386DT
—	New	376T x 392-6
3308NL	Obsolete	—
3308DT	Obsolete	—
—	New	388 x Ives 8190 Series Pull
—	New	360T x Ives 8190 Series Pull

*New trims not compatible with old devices, neither are old trims with new devices.

Nomenclature – How to Order

		EL	33	27A	-L	-16	-F	LBR	3'	US3	RHR										
CD	Cylinder Dogging - Panic Only																				
CX	Chexit Delayed Egress - Rim Only																				
EL	Electric Latch Retraction																				
HD-EL	Electric Latch Retraction with Hex Dogging																				
QEL	Quiet Electric Latch																				
HH	Hurricane																				
LD	Less Dogging																				
LX	Latchbolt Monitoring																				
LX-LC	Latch Bolt Monitor Low Current																				
LX-RX	Latchbolt Monitor / Request to Exit																				
LX-RX-LC	Latchbolt Monitor / Request to Exit Low Current																				
PL	Pullman Latch																				
PN	Pneumatic																				
RX	Request to Exit																				
RX-LC	Request to Exit Low Current																				
RX2	Request to Exit Double Switch																				
SS	Signal Switch																				
WP-RX	Waterproof Request to Exit																				
35A	Series 35A-smooth																				
33A	Series 33A-grooved																				
A	Rim Device																				
27A	Surface Mounted Vertical Rod Device																				
47A	Concealed Vertical Rod Device																				
48A	Concealed Vertical Rod Device																				
49A	Concealed Vertical Cable Device																				
DT	Dummy Trim																				
EO	Exit Only																				
L	Lever (Classroom)																				
L-BE	Lever-Blank Escutcheon (Passage)																				
L-DT	Lever-Dummy Trim																				
L-NL	Rigid Lever - Night Latch (Key retracts Latchbolt)																				
NL	Night Latch (Key retracts Latchbolt)																				
NL-OP	Night Latch Cylinder Assembly – Optional Pull																				
T	Thumbturn																				
TL	Turn Lever																				
T-BE	Thumbturn-Blank Escutcheon																				
TL-BE	Turn Lever-Blank Escutcheon (Passage)																				
XX	Lever Style 06 standard Optional 01, 02, 02KN, 03, 03KN, 05, 06KN, 07, 12 (handed), 16, 17, 17KN, 18, ACC, AST, MER, STA																				
F	Fire Exit Device 27A, 47A, 48A, 49A Only																				
LBR	Less Bottom Rod																				
LBL	Less Bottom Latch																				
ALK	Standard Alarm Kit																				
ALK-AR1	Auto-Reset 1 1/2 minute Alarm Kit																				
ALK-AR3	Auto-Reset 3 minute Alarm Kit																				
ALK-AR6	Auto-Reset 4 1/2 minute Alarm Kit																				
2'	2' Device (2' Door Size) 27A, 47A or 49A only																				
3'	3' Device (2' 4" – 3' Door Size)																				
4'	4' Device (2' 10" – 4' Door Size)																				
Finishes	US3, US4, US10, US15 (35A only), US26, US26D, US26D-AM, US28, 313, 315																				
HR	Handing – RHR or LHR																				

Single Door Applications

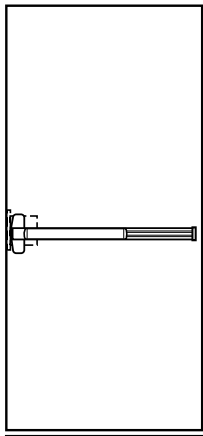

Single mortise lock device

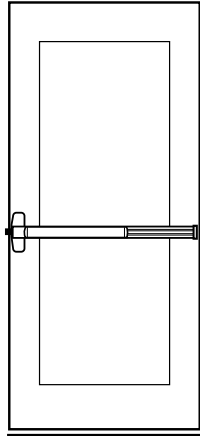

Single rim device

Door Handing

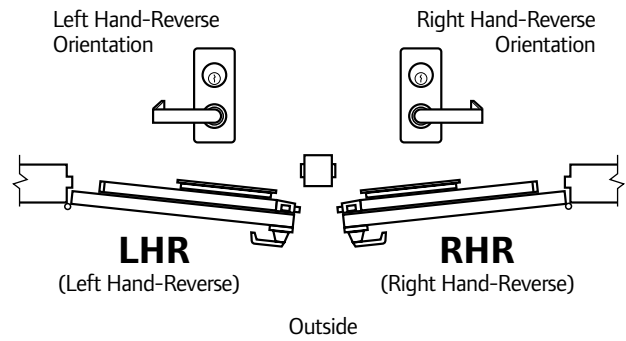

Double Door Applications

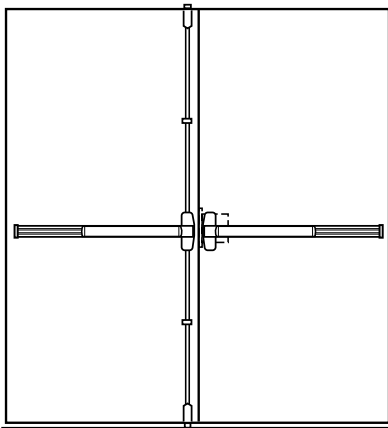

Mortise lock and surface mounted or concealed vertical cable/rod device combination—same direction

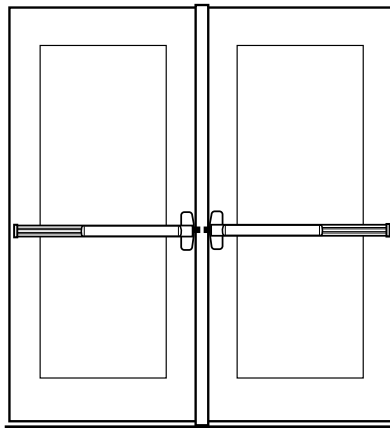

Two rim devices with mullion—same direction

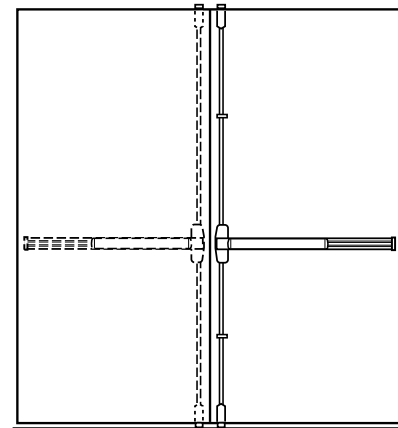

Two vertical rods—double egress

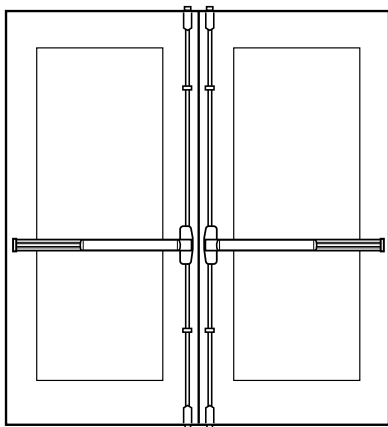

Two surface mounted vertical rod devices—same direction (do not use with overlapping astragal)

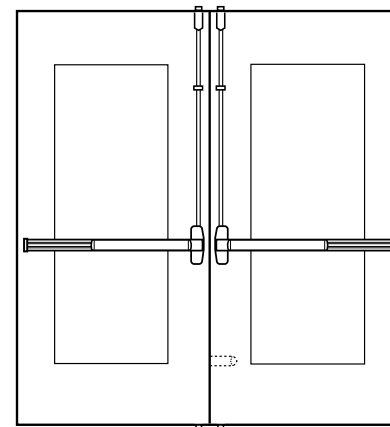

Two Fire Exit Hardware vertical cables/rods with auxiliary fire latch-LBR option

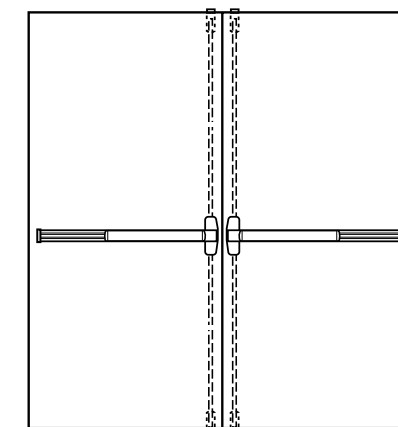

Two concealed vertical cables/rods



1439 Roller
ships standard, optional strikes available



299 Strike
needs to be specified for Hollow Metal Frames

33A and 35A for all types of single and double doors with mullion, UL listed for Panic Exit Hardware. Devices are ANSI A156.3 – 2001 Grade 1. The 35A has a smooth mechanism case and the 33A has grooved case. The rim device is non-handed except when the SS (Signal Switch) option is used. See opposite page for available outside trim and device functions.

33A/35A fits door stiles as narrow as 1¾" (44mm). Newly designed device has a one piece center case cover.

Finishes – US3, US4, US10, US15 (35A Only) US26, US26D, US26D-AM, US28, 313 and 315.

Specifications	
Device Lengths	3' 2' 4" to 3' (711mm to 914 mm) Door Size 4' 2'10" to 4' (864 mm to 1219 mm) Door Size
Device Centerline from Finished Floor	39 ¹³ / ₁₆ " (1011 mm) 39 ¹ / ₁₆ " (1008 mm) with Mullion
Center Case Dimensions	8 ³ / ₁₆ " x 1 ⁹ / ₁₆ " x 2 ¹³ / ₃₂ " (208mm x 40mm x 62mm)
Mechanism Case Dimensions	2¼" x 2¼" (57mm x 57mm)
Projection	Pushbar Neutral – 3 ¹³ / ₁₆ " (97 mm) Pushbar Depressed – 3 ¹ / ₁₆ " (78 mm)
Latch Bolt	Deadlocking, ¾" (19mm) throw
Fasteners & Sex Bolts (SNB)	Includes 1¾" (44mm) – 2¼" (57mm) Wood & Metal Doors #425 SNB furnished standard for end case #325 SNB furnished standard for EO (exit only device)
Electric Options	ALK Alarm Kit CX Chexit Delayed Exit EL Electric Latch Retraction HD-EL Electric Latch Retraction with Hex Dogging QEL Quiet Electric Latch Retraction RX Request to Exit, WP-RX Waterproof Option LX Latchbolt Monitoring LX-RX Request to Exit / Latchbolt Monitoring RX-LC, LX-LC, LX-RX-LC Low Current Option for RX, LX, LX-RX SS Signal Switch
Miscellaneous Options	GBK Glass Bead Kit PN Pneumatic HH Hurricane SG Safety Glow SEC Security Screws SNB Sex Bolts
Dogging Feature	Hex Dogging Standard CD Cylinder Dogging LD Less Dogging
Strikes	1439 – Dull Black Optional Strikes

QEL
Quiet Electric Latch Retraction

- Bolt retraction via switch
- Converts exit door to push-pull operation

RX
Pushpad Monitor Switch

- Signals use of an opening
- SPDT switch to monitor pushpad

CX
Chexit Delayed Exit

- Meets NFPA 101 requirements
- Self-contained controls, locking, alarm

ALK
Alarm Exit Kit

- Unauthorized opening triggers 85-decibel horn
- Set in armed or disarmed mode by key

EL
Electric Latch Retraction

- Enables remote unlatching
- Alternative to manual dogging

SG
Safety Glow

- Self illuminating touchpad
- No batteries or electronics

E (E360L)
Electric Lever Trim

- Electrified remote locking/unlocking
- Fail safe & fail secure options available
- No key override



CD
Cylinder Dogging





- Replaces hex key dogging
- Requires standard 1¹/₄" mortise cylinder

PN
Pneumatic Latch Retraction

- For areas where electrical devices banned
- Special linkage for mechanical or pneumatic dogging

Standard Trim

	EO	DT	NL	NL-OP
				
	Exit Only No Outside Trim	Dummy Trim Pull when Dogged	Night Latch Key Retracts Latchbolt	Night Latch Key Retracts Latchbolt Optional Pull Required
Product Description	33A-EO 35A-EO	33A-DT 35A-DT	33A-NL 35A-NL	33A-NL-OP 35A-NL-OP
Trim Description	—	386DT	386NL	388
Base Size	—	7 ¹⁵ / ₃₂ " x 1 ⁵ / ₈ " (190x41mm)	7 ¹⁵ / ₃₂ " x 1 ⁵ / ₈ " (190x41mm)	7 ¹ / ₂ " x 1 ¹¹ / ₁₆ " (190x43mm)
Grip Size	—	8 ¹ / ₂ " x 4 ⁵ / ₁₆ " (216x110mm)	8 ¹ / ₂ " x 4 ⁵ / ₁₆ " (216x110mm)	—
Projection	—	2 ⁷ / ₁₆ " (62mm)	2 ⁷ / ₁₆ " (62mm)	1" (25mm)
ANSI Function	01	02	03	03
Cylinder Type	—	—	Rim	Rim
Handing	—	—	Handed	—
Optional Trim	—	x360L-DT x550DT x IVES 8190	—	x550DT x IVES 8190 10"

	L	L-BE	T	T-BE
				
	Lever Key Locks and Unlocks	Lever Blank Escutcheon Always Operable (No Cylinder)	Thumbturn Key Locks and Unlocks	Thumbturn Always Operable (No Cylinder)
Product Description	33A-L 35A-L	33A-L-BE 35A-L-BE	33A-T 35A-T	33A-T-BE 35A-T-BE
Trim Description	360L	360L-BE	360T	360T-BE
Base Size	7 ¹ / ₂ " x 1 ¹¹ / ₁₆ " x 7 ⁷ / ₈ " (190x43x22mm)	7 ¹ / ₂ " x 1 ¹¹ / ₁₆ " x 7 ⁷ / ₈ " (190x43x22mm)	7 ¹ / ₂ " x 1 ¹¹ / ₁₆ " x 7 ⁷ / ₈ " (190x43x22mm)	7 ¹ / ₂ " x 1 ¹¹ / ₁₆ " x 7 ⁷ / ₈ " (190x43x22mm)
Grip Size	—	—	—	—
Projection	3" (76mm)	3" (76mm)	1 ¹³ / ₁₆ " (46mm)	1 ¹³ / ₁₆ " (46mm)
ANSI Function	08 or 09 Field Selectable	—	11 or 12 Field Selectable	—
Cylinder Type	1 ¹ / ₄ " Mortise	—	1 ¹ / ₄ " Mortise	—
Handing	Handed/Reversible	Handed/Reversible	—	—
Optional Trim	—	E360L-BE	—	E360T-BE

Note: 360L & 360T used on Wood Door require the 33A-WDA cover plate

Notes

3327A/3527A Surface Mounted Vertical Rod Device

VON DUPRIN.



3327A and 3527A for all types of single and double doors, UL listed for Panic Exit Hardware. Devices are ANSI A156.3 – 2001 Grade 1. The 3527A has a smooth mechanism case and the 3327A has grooved case. The surface vertical rod device is non-handed except when the SS (Signal Switch) option is used. See opposite page for available outside trim and device functions.

3327A/3527A fits door stiles as narrow as 1 3/4" (44mm). Newly designed device has a one piece center case cover.

Finishes – US3, US4, US10, US15 (35A Only) US26, US26D, US26D-AM, US28, 313 and 315.

Specifications	
Device Lengths	2' 2' (610 mm) Door Size - Shipped Less UL Label 3' 2'4" to 3' (660mm to 914 mm) Door Size 4' 2'8" to 4' (813 mm to 1219 mm) Door Size
Device Centerline from Finished Floor	39 13/16" (1006mm)
Center Case Dimensions	8 3/16" x 2 13/32" x 1 9/16" (208mm x 62mm x 40mm)
Mechanism Case Dimensions	2 1/4" x 2 1/4" (57mm x 57mm)
Projection	Pushbar Neutral – 3 13/16" (97 mm) Pushbar Depressed – 3 1/16" (78 mm)
Latch Bolt	Deadlocking Anti-friction Top & Bottom Bolt 5/8" (16mm) throw
Door Undercut	1/4" (7mm)
Top & Bottom Latch	4 1/2" x 2 1/8" x 1 1/2" (114mm x 54mm x 38mm)
Vertical Rods	1/2" square tubing, standard rods accommodate 7'(2134mm) door Top rod length is 34 15/16" (887mm) Bottom rod length is 31 1/4" (794mm) Extension rods available 1' (205mm) or 3' (914mm) for doors over 7' One piece top rod available for 8' (2438mm) -10' (3048mm) door
Fasteners & Sex Bolts (SNB)	Includes 1 3/4" (44mm) – 2 1/4" (57mm) Wood & Metal Doors #425 SNB furnished standard for end case #325 SNB furnished standard for EO (exit only device) #325 SNB furnished for top and bottom latches
Electric Options	ALK Alarm Kit EL Electric Latch Retraction HD-EL Electric Latch Retraction with Hex Dogging QEL Quiet Electric Latch Retraction RX Request to Exit, WP-RX Waterproof Option LX Latchbolt Monitoring LX-RX Request to Exit / Latchbolt Monitoring RX-LC, LX-LC, LX-RX-LC Low Current Option for RX, LX, LX-RX SS Signal Switch
Miscellaneous Options	GBK Glass Bead Kit PL Pullman Latch PN Pneumatic HH Hurricane LBR Less Bottom Rod SG Safety Glow SEC Security Screws SNB Sex Bolts
Dogging Feature	Hex Dogging Standard CD Cylinder Dogging LD Less Dogging
Strikes	Top – 266 – Dull Black, Bottom – 248L4 & 304L – Unfinished Optional Strikes



QEL
Quiet Electric Latch Retraction
• Bolt retraction via switch
• Converts exit door to push-pull operation

CD
Cylinder Dogging
• Replaces hex key dogging
• Requires standard 1 1/4" mortise cylinder

EL
Electric Latch Retraction
• Enables remote unlatching
• Alternative to manual dogging

ALK
Alarm Exit Kit
• Unauthorized opening triggers 85-decibel horn
• Set in armed or disarmed mode by key

PN
Pneumatic Latch Retraction
• For areas where electrical devices banned
• Special linkage for mechanical or pneumatic dogging

DI
Dogging Indicator
• Monitor dogging status without a control panel
• Red indicator light shows visibility to dogging from over 75 feet





E (E360L)
Electric Lever Trim
• Electrified remote locking/unlocking
• Fail safe & fail secure options available
• No key override



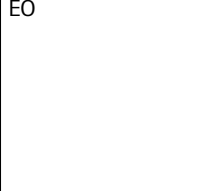

SG
Safety Glow
• Self illuminating touchpad
• No batteries or electronics

RX
Pushpad Monitor Switch
• Signals use of an opening
• SPDT switch to monitor pushpad

3327A/3527A Surface Mounted Vertical Rod Device

Standard Trim

	EO	DT	NL	NL-OP	TL
					
	Exit Only No Outside Trim	Dummy Trim Pull when Dogged	Night Latch Key Retracts Latchbolt	Night Latch Key Retracts Latchbolt Optional Pull Required	Thumbturn Key Locks & Unlocks
Product Description	3327A-EO 3527A-EO	3327A-DT 3527A-DT	3327A-NL 3527A-NL	3327A-NL-OP 3527A-NL-OP	3327A-TL 3527A-TL
Trim Description	—	386DT	386NL	388	374T x 386
Base Size	—	7 ¹ / ₃₂ " x 1 ⁵ / ₈ " (190x41mm)	7 ¹ / ₃₂ " x 1 ⁵ / ₈ " (190x41mm)	7 ¹ / ₂ " x 1 ¹¹ / ₁₆ " (190x43mm)	7 ¹ / ₂ " x 1 ¹¹ / ₁₆ " x 7 ⁸ / ₈ " (190x43mmx22mm)
Grip Size	—	8 ¹ / ₂ " x 4 ⁵ / ₁₆ " (216x110mm)	8 ¹ / ₂ " x 4 ⁵ / ₁₆ " (216x110mm)	—	—
Projection	—	2 ⁷ / ₁₆ " (62mm)	2 ⁷ / ₁₆ " (62mm)	1" (25mm)	1 ¹³ / ₁₆ " (46mm)
ANSI Function	01	02	03	03	11-12 Field Selectable
Cylinder Type	—	—	Rim	Rim	1 ¹ / ₄ "Mortise
Handing	—	—	Handed	—	—
Optional Trim	—	x 360L-DT x 550DT x IVES 8190	—	x 550DT x IVES 8190 10"	x 392-6

	TL-BE	L	L-BE	T	T-BE
					
	Thumbturn-Blank Escutcheon Always Operable (No Cylinder)	Lever Key Locks and Unlocks	Lever Blank Escutcheon Always Operable (No Cylinder)	Thumbturn Key Locks and Unlocks	Thumbturn Always Operable (No Cylinder)
Product Description	3327A-TL-BE 3527A-TL-BE	3327A-L 3527A-L	3327A-L-BE 3527A-L-BE	3327A-T 3527A-T	3327A-T-BE 3527A-T-BE
Trim Description	374T-BE x 386	360L	360L-BE	360T	360T-BE
Base Size	7 ¹ / ₂ " x 1 ¹¹ / ₁₆ " x 7 ⁸ / ₈ " (190x43x22mm)	7 ¹ / ₂ " x 1 ¹¹ / ₁₆ " x 7 ⁸ / ₈ " (190x43x22mm)	7 ¹ / ₂ " x 1 ¹¹ / ₁₆ " x 7 ⁸ / ₈ " (190x43x22mm)	7 ¹ / ₂ " x 1 ¹¹ / ₁₆ " x 7 ⁸ / ₈ " (190x43x22mm)	7 ¹ / ₂ " x 1 ¹¹ / ₁₆ " x 7 ⁸ / ₈ " (190x43x22mm)
Grip Size	8 ¹ / ₂ " x 4 ⁵ / ₁₆ " (216x110mm)	—	—	—	—
Projection	1 ¹³ / ₁₆ " (46mm)	3" (76mm)	3" (76mm)	1 ¹³ / ₁₆ " (46mm)	1 ¹³ / ₁₆ " (46mm)
ANSI Function	—	08 or 09 Field Selectable	—	11 or 12 Field Selectable	—
Cylinder Type	—	1 ¹ / ₄ "Mortise	—	1 ¹ / ₄ "Mortise	—
Handing	—	Handed/Reversible	Handed/Reversible	—	—
Optional Trim	x 392-6	—	E360L-BE	—	E360T-BE

Note: 360L & 360T used on Wood Door require the 33A-WDA cover plate
374T used on Wood Door require #10-WDA cover plate

Notes

3327A-F/3527A-F Fire Exit Surface Mounted Vertical Rod Device

VON DUPRIN



3327A-F and 3527A-F for all types of double doors up to 8' x 10' (2438mm x 2540mm), UL listed for Fire Exit Hardware. **See page 28 for detailed information on UL listed fire exit hardware label and door opening size information.** Devices are ANSI A156.3 – 2001 Grade 1. The 3527A-F has a smooth mechanism case and the 3327A-F has grooved case. The surface vertical rod device is non-handed except when the SS (Signal Switch) option is used. See opposite page for available outside trim and device functions.

3327A-F/3527A-F fits door stiles as narrow as 2³/₁₆" (56 mm). Newly designed device has a one piece center case cover.

Finishes – US3, US4, US10, US15 (35A Only) US26, US26D, US26D-AM, US28, 313 and 315.

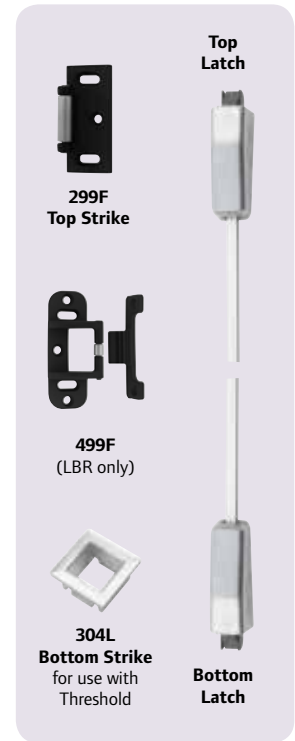

Specifications

Device Lengths	2' 2' (610 mm) Door Size - Shipped Less UL Label 3' 2'4" to 3' (660mm to 914 mm) Door Size 4' 2'8" to 4' (813 mm to 1219 mm) Door Size
Device Centerline from Finished Floor	39 1 ³ / ₁₆ " (1006mm)
Center Case Dimensions	8 ³ / ₁₆ " x 1 ⁹ / ₁₆ " x 2 ¹³ / ₃₂ " (208mm x 62mm x 40mm)
Mechanism Case Dimensions	2 ¹ / ₄ " x 2 ¹ / ₄ " (57mm x 57mm)
Projection	Pushbar Neutral – 3 ¹³ / ₁₆ " (97 mm) Pushbar Depressed – 3 ¹ / ₁₆ " (78 mm)
Latch Bolt	Deadlocking Anti-friction Top & Bottom Bolt 5/8" (16mm) throw
Door Undercut	1/4" (7mm)
Top & Bottom Latch	4 1/2" x 2 1/8" x 1 1/2" (114mm x 54mm x 38mm)
Vertical Rods	1/2" square tubing, standard rods accommodate 7' (2134mm) door Top rod length is 34 ¹⁹ / ₁₆ " (887mm) Bottom rod length is 31 1/4" (794mm) Extension rods available 1' (205mm) or 3'(914mm) for doors over 7' One piece top rod available for 8'(2438mm) -10' (3048mm) door
Fasteners & Sex Bolts (SNB)	Includes 1 3/4" (44mm) – 2 1/4" (57mm) Wood & Metal Doors #425 SNB furnished standard for end case #325 SNB furnished standard for EO (exit only device) #325 SNB furnished for top and bottom latches
Electric Options	ALK Alarm Kit EL Electric Latch Retraction HD-EL Electric Latch Retraction with Hex Dogging QEL Quiet Electric Latch Retraction RX Request to Exit, WP-RX Waterproof Option LX Latchbolt Monitoring LX-RX Request to Exit / Latchbolt Monitoring RX-LC, LX-LC, LX-RX-LC Low Current Option for RX, LX, LX-RX SS Signal Switch
Miscellaneous Options	GBK Glass Bead Kit PN Pneumatic HH Hurricane LBR Less Bottom Rod SG Safety Glow SEC Security Screws SNB Sex Bolts
Strikes	Top – 299F (499F LBR) – Dull Black, Bottom – 304L – Unfinished Optional Strikes

QEL
Quiet Electric Latch Retraction

- Bolt retraction via switch
- Converts exit door to push-pull operation

RX
Pushpad Monitor Switch

- Signals use of an opening
- SPDT switch to monitor pushpad

EL
Electric Latch Retraction

- Enables remote unlatching
- Alternative to manual dogging

ALK
Alarm Exit Kit

- Unauthorized opening triggers 85-decibel horn
- Set in armed or disarmed mode by key

PN
Pneumatic Latch Retraction

- For areas where electrical devices banned
- Special linkage for mechanical or pneumatic dogging

SG
Safety Glow





- Self illuminating touchpad
- No batteries or electronics





E (E360L)
Electric Lever Trim

- Electrified remote locking/unlocking
- Fail safe & fail secure options available
- No key override

3327A-F/3527A-F Fire Exit Surface Mounted Vertical Rod Device

Standard Trim

	EO	DT 	NL 	NL-OP 	TL 
	Exit Only No Outside Trim	Dummy Trim Pull when Dogged (Not recommended for Fire Device)	Night Latch Key Retracts Latchbolt	Night Latch Key Retracts Latchbolt Optional Pull Required	Thumbturn Key Locks & Unlocks
Product Description	3327A-EO-F 3527A-EO-F	3327A-DT-F 3527A-DT-F	3327A-NL-F 3527A-NL-F	3327A-NL-OP-F 3527A-NL-OP-F	3327A-TL-F 3527A-TL-F
Trim Description	—	386DT	386NL	388	374T x 386
Base Size	—	7 ¹ / ₃₂ " x 1 ⁵ / ₈ " (190x41mm)	7 ¹ / ₃₂ " x 1 ⁵ / ₈ " (190x41mm)	7 ¹ / ₂ " x 1 ¹¹ / ₁₆ " (190x43mm)	7 ¹ / ₂ " x 1 ¹¹ / ₁₆ " x 7 ⁸ / ₈ " (190x43mmx22mm)
Grip Size	—	8 ¹ / ₂ " x 4 ⁵ / ₁₆ " (216x110mm)	8 ¹ / ₂ " x 4 ⁵ / ₁₆ " (216x110mm)	—	8 ¹ / ₂ " x 4 ⁵ / ₁₆ " (216x110mm)
Projection	—	2 ⁷ / ₁₆ " (62mm)	2 ⁷ / ₁₆ " (62mm)	1" (25mm)	1 ¹³ / ₁₆ " (46mm)
ANSI Function	01	02	03	03	11-12 Field Selectable
Cylinder Type	—	—	Rim	Rim	1 ¹ / ₄ "Mortise
Handing	—	—	Handed	—	—
Optional Trim	—	x 360L-DT x 550DT x IVES 8190	—	x 550DT x IVES 8190 10"	x 392-6

	TL-BE 	L 	L-BE 	T 	T-BE 
	Thumbturn-Blank Escutcheon Always Operable (No Cylinder)	Lever Key Locks and Unlocks	Lever Blank Escutcheon Always Operable (No Cylinder)	Thumbturn Key Locks and Unlocks (Behind C/Case)	Thumbturn Always Operable (No Cylinder) (Behind C/Case)
Product Description	3327A-TL-BE-F 3527A-TL-BE-F	3327A-L-F 3527A-L-F	3327A-L-BE-F 3527A-L-BE-F	3327A-T-F 3527A-T-F	3327A-T-BE-F 3527A-T-BE-F
Trim Description	374T-BE x 386	360L	360L-BE	360T	360T-BE
Base Size	7 ¹ / ₂ " x 1 ¹¹ / ₁₆ " x 7 ⁸ / ₈ " (190x43x22mm)	7 ¹ / ₂ " x 1 ¹¹ / ₁₆ " x 7 ⁸ / ₈ " (190x43x22mm)	7 ¹ / ₂ " x 1 ¹¹ / ₁₆ " x 7 ⁸ / ₈ " (190x43x22mm)	7 ¹ / ₂ " x 1 ¹¹ / ₁₆ " x 7 ⁸ / ₈ " (190x43x22mm)	7 ¹ / ₂ " x 1 ¹¹ / ₁₆ " x 7 ⁸ / ₈ " (190x43x22mm)
Grip Size	8 ¹ / ₂ " x 4 ⁵ / ₁₆ " (216x110mm)	—	—	—	—
Projection	2 ⁷ / ₁₆ " (62mm)	3" (76mm)	3" (76mm)	1 ¹³ / ₁₆ " (46mm)	1 ¹³ / ₁₆ " (46mm)
ANSI Function	—	08 or 09 Field Selectable	—	11 or 12 Field Selectable	—
Cylinder Type	—	1 ¹ / ₄ "Mortise	—	1 ¹ / ₄ "Mortise	—
Handing	—	Handed/Reversible	Handed/Reversible	—	—
Optional Trim	x 392-6	—	E360L-BE	—	E360T-BE

Note: 360L & 360T used on Wood Door require the 33A-WDA cover plate
374T used on Wood Door require #10-WDA cover plate

Notes

3347A/3547A Concealed Vertical Rod Device

VON DUPRIN.



3347A and 3547A for all types of single and double doors, UL listed for Panic Exit Hardware. Devices are ANSI A156.3 – 2001 Grade 1. The 3547A has a smooth mechanism case and the 3347A has grooved case. The concealed vertical rod device is non-handed except when the SS (Signal Switch) option is used. See opposite page for available outside trim and device functions.

3347A/3547A fits door stiles as narrow as 2-1/8" (44 mm), wood door stiles as narrow as 4" (102mm). Newly designed device has a one piece center case cover.

Finishes – US3, US4, US10, US15 (35A Only) US26, US26D, US26D-AM, US28, 313 and 315.



Specifications

Device Lengths	2' 2' (610 mm) Door Size - Shipped Less UL Label 3' 2'4" to 3' (660mm to 914 mm) Door Size 4' 2'8" to 4' (813 mm to 1219 mm) Door Size
Device Centerline from Finished Floor	39 13/16" (1006mm)
Center Case Dimensions	8 3/16" x 2 13/32" x 1 1/16" (208mm x 62mm x 40mm)
Mechanism Case Dimensions	2 1/4" x 2 1/4" (57mm x 57mm)
Projection	Pushbar Neutral – 3 13/16" (97 mm) Pushbar Depressed – 3 1/16" (78 mm)
Latch Bolt	Deadlocking Anti-friction Top & Bottom Bolt 5/8" (16mm) throw
Door Undercut	1/4" (7mm)
Top & Bottom Latch	3 3/4" x 1 1/2" x 1" (114mm x 54mm x 38mm)
Vertical Rods	Round 2 piece adjustable rods Top rod adjustable from 6'8" (2027mm) to 8'4" (2533mm) Bottom rod adjustable from 35 5/8" (905mm) to 49 5/8" (1260mm) Extension rod kits available for doors over 8'4" (2533mm)
Fasteners & Sex Bolts (SNB)	Includes 1 3/4" (44mm) – 2 1/4" (57mm) Wood & Metal Doors #425 SNB furnished standard for end case #325 SNB furnished standard for EO (exit only device)
Electric Options	ALK Alarm Kit EL Electric Latch Retraction HD-EL Electric Latch Retraction with Hex Dogging QEL Quiet Electric Latch Retraction RX Request to Exit, WP-RX Waterproof Option LX Latchbolt Monitoring LX-RX Request to Exit / Latchbolt Monitoring RX-LC, LX-LC, LX-RX-LC Low Current Option for RX, LX, LX-RX SS Signal Switch
Miscellaneous Options	GBK Glass Bead Kit PL Pullman Latch PN Pneumatic HH Hurricane INS-2/INS-4 Insulclad Kits 1/2" / 1/4" Panels LBR Less Bottom Rod SG Safety Glow SEC Security Screws SNB Sex Bolts
Dogging Feature	Hex Dogging Standard CD Cylinder Dogging LD Less Dogging
Strikes	Top – 388 – Unfinished, Bottom – 385A – Unfinished Optional Strikes

QEL
Quiet Electric Latch Retraction

- Bolt retraction via switch
- Converts exit door to push-pull operation

CD
Cylinder Dogging

- Replaces hex key dogging
- Requires standard 1 1/4" mortise cylinder

RX
Pushpad Monitor Switch

- Signals use of an opening
- SPDT switch to monitor pushpad

ALK
Alarm Exit Kit

- Unauthorized opening triggers 85-decibel horn
- Set in armed or disarmed mode by key

EL
Electric Latch Retraction

- Enables remote unlatching
- Alternative to manual dogging

DI
Dogging Indicator

- Monitor dogging status without a control panel
- Red indicator light shows visibility to dogging from over 75 feet

PN
Pneumatic Latch Retraction

- For areas where electrical devices banned
- Special linkage for mechanical or pneumatic dogging





SG
Safety Glow





- Self illuminating touchpad
- No batteries or electronics

E (E360L)
Electric Lever Trim

- Electrified remote locking/unlocking
- Fail safe & fail secure options available
- No key override

Standard Trim

	EO	DT	NL	NL-OP	TL
					
	Exit Only No Outside Trim	Dummy Trim Pull when Dogged	Night Latch Key Retracts Latchbolt	Night Latch Key Retracts Latchbolt Optional Pull Required	Thumbturn Key Locks & Unlocks
Product Description	3347A-EO 3547A-EO	3347A-DT 3547A-DT	3347A-NL 3547A-NL	3347A-NL-OP 3547A-NL-OP	3347A-TL 3547A-TL
Trim Description	—	386DT	386NL	388	376T x 386
Base Size	—	7 ¹ / ₃₂ " x 1 ⁵ / ₈ " (190x41mm)	7 ¹ / ₃₂ " x 1 ⁵ / ₈ " (190x41mm)	7 ¹ / ₂ " x 1 ¹¹ / ₁₆ " (190x43mm)	7 ¹ / ₂ " x 1 ¹¹ / ₁₆ " x 7 ⁸ / ₁₆ " (190x43mmx22mm)
Grip Size	—	8 ¹ / ₂ " x 4 ⁹ / ₁₆ " (216x110mm)	8 ¹ / ₂ " x 4 ⁹ / ₁₆ " (216x110mm)	—	8 ¹ / ₂ " x 4 ⁹ / ₁₆ " (216x110mm)
Projection	—	2 ⁷ / ₁₆ " (62mm)	2 ⁷ / ₁₆ " (62mm)	1" (25mm)	1 ¹³ / ₁₆ " (46mm)
ANSI Function	01	02	03	03	11-12 Field Selectable
Cylinder Type	—	—	Rim	Rim	1 ¹ / ₄ "Mortise
Handing	—	—	Handed	—	—
Optional Trim	—	x 360L-DT x 550DT x IVES 8190	—	x 550DT x IVES 8190 10"	x 392-6

	TL-BE	L	L-BE	T	T-BE
					
	Thumbturn-Blank Escutcheon Always Operable (No Cylinder)	Lever Key Locks and Unlocks	Lever Blank Escutcheon Always Operable (No Cylinder)	Thumbturn Key Locks and Unlocks (Behind C/Case)	Thumbturn Always Operable (No Cylinder) (Behind C/Case)
Product Description	3347A-TL-BE 3547A-TL-BE	3347A-L 3547A-L	3347A-L-BE 3547A-L-BE	3347A-T 3547A-T	3347A-T-BE 3547A-T-BE
Trim Description	376T-BE x 386	360L	360L-BE	360T	360T-BE
Base Size	7 ¹ / ₂ " x 1 ¹¹ / ₁₆ " x 7 ⁸ / ₁₆ " (190x43x22mm)	7 ¹ / ₂ " x 1 ¹¹ / ₁₆ " x 7 ⁸ / ₁₆ " (190x43x22mm)	7 ¹ / ₂ " x 1 ¹¹ / ₁₆ " x 7 ⁸ / ₁₆ " (190x43x22mm)	7 ¹ / ₂ " x 1 ¹¹ / ₁₆ " x 7 ⁸ / ₁₆ " (190x43x22mm)	7 ¹ / ₂ " x 1 ¹¹ / ₁₆ " x 7 ⁸ / ₁₆ " (190x43x22mm)
Grip Size	8 ¹ / ₂ " x 4 ⁹ / ₁₆ " (216x110mm)	—	—	—	—
Projection	2 ⁷ / ₁₆ " (62mm)	3" (76mm)	3" (76mm)	1 ¹³ / ₁₆ " (46mm)	1 ¹³ / ₁₆ " (46mm)
ANSI Function	—	08 or 09 Field Selectable	—	11 or 12 Field Selectable	—
Cylinder Type	—	1 ¹ / ₄ "Mortise	—	1 ¹ / ₄ "Mortise	—
Handing	—	Handed/Reversible	Handed/Reversible	—	—
Optional Trim	x 392-6	—	E360L-BE	—	E360T-BE

Note: 360L & 360T used on Wood Door require the 33A-WDA cover plate
376T used on Wood Door require #10-WDA cover plate

Notes

3347A-F/3547A-F Fire Exit Concealed Vertical Rod Device **VON DUPRIN**



3347A-F and 3547A-F for all types of double doors up to 8' x 10' (2438mm x 2540mm), UL listed for Fire Exit Hardware. **See page 37 for detailed information on UL listed fire exit hardware label and door opening size information.** Devices are ANSI A156.3 – 2001 Grade 1. The 3547A-F has a smooth mechanism case and the 3347A-F has grooved case. The concealed vertical rod device is non-handed except when the SS (Signal Switch) option is used. See opposite page for available outside trim and device functions.

3347A-F/3527A-F fits door stiles as narrow as 3½" (90mm). Newly designed device has a one piece center case cover.

Finishes – US3, US4, US10, US15 (35A Only) US26, US26D, US26D-AM, US28, 313 and 315.

Specifications	
Device Lengths	2' 2' (610 mm) Door Size - Shipped Less UL Label 3' 2'4" to 3' (660mm to 914 mm) Door Size 4' 2'8" to 4' (813 mm to 1219 mm) Door Size
Device Centerline from Finished Floor	39 13/16" (1006mm)
Center Case Dimensions	83/16" x 213/32" x 19/16" (208mm x 62mm x 40mm)
Mechanism Case Dimensions	2¼" x 2¼" (57mm x 57mm)
Projection	Pushbar Neutral – 313/16" (97 mm) Pushbar Depressed – 31/16" (78 mm)
Latch Bolt	Deadlocking Anti-friction Top & Bottom Bolt 5/8" (16mm) throw
Door Undercut	¼" (7mm)
Top & Bottom Latch	4½" x 2½" x 1½" (114mm x 54mm x 38mm)
Vertical Rods	Round 2 piece adjustable rods Top rod adjustable from 6'8" (2027mm) to 8'4" (2533mm) Bottom rod adjustable from 35 5/8" (905mm) to 49 5/8" (1260mm) Extension rod kits available for doors over 8'4" (2533mm)
Fasteners & Sex Bolts (SNB)	Includes 1¾" (44mm) – 2¼" (57mm) Wood & Metal Doors #425 SNB furnished standard for end case #325 SNB furnished standard for EO (exit only device)
Electric Options	ALK Alarm Kit EL Electric Latch Retraction HD-EL Electric Latch Retraction with Hex Dogging QEL Quiet Electric Latch Retraction RX Request to Exit, WP-RX Waterproof Option LX Latchbolt Monitoring LX-RX Request to Exit / Latchbolt Monitoring RX-LC, LX-LC, LX-RX-LC Low Current Option for RX, LX, LX-RX SS Signal Switch
Miscellaneous Options	GBK Glass Bead Kit PN Pneumatic HH Hurricane LBR Less Bottom Rod SG Safety Glow SEC Security Screws SNB Sex Bolts
Strikes	Top – 338 – Dull Black, Bottom – 385A – Unfinished Optional Strikes

QEL
Quiet Electric Latch Retraction
• Bolt retraction via switch
• Converts exit door to push-pull operation

RX
Pushpad Monitor Switch
• Signals use of an opening
• SPDT switch to monitor pushpad

EL
Electric Latch Retraction
• Enables remote unlatching
• Alternative to manual dogging





ALK
Alarm Exit Kit
• Unauthorized opening triggers 85-decibel horn
• Set in armed or disarmed mode by key





PN
Pneumatic Latch Retraction
• For areas where electrical devices banned
• Special linkage for mechanical or pneumatic dogging

SG
Safety Glow
• Self illuminating touchpad
• No batteries or electronics

E (E360L)
Electric Lever Trim
• Electrified remote locking/unlocking
• Fail safe & fail secure options available
• No key override

Standard Trim

	EO	DT 	NL 	NL-OP 	TL 
	Exit Only No Outside Trim	Dummy Trim Pull when Dogged (Not recommended for Fire Device)	Night Latch Key Retracts Latchbolt	Night Latch Key Retracts Latchbolt Optional Pull Required	Thumbturn Key Locks & Unlocks
Product Description	3347A-EO-F 3547A-EO-F	3347A-DT-F 3547A-DT-F	3347A-NL-F 3547A-NL-F	3347A-NL-OP-F 3547A-NL-OP-F	3347A-TL-F 3547A-TL-F
Trim Description	—	386DT	386NL	388	376T x 386DT
Base Size	—	7 ¹ / ₂ " x 1 ⁵ / ₈ " (190x41mm)	7 ¹ / ₂ " x 1 ⁵ / ₈ " (190x41mm)	7 ¹ / ₂ " x 1 ¹ / ₁₆ " (190x43mm)	7 ¹ / ₂ " x 1 ¹ / ₁₆ " x 7 ⁸ / ₈ " (190x43mmx22mm)
Grip Size	—	8 ¹ / ₂ " x 4 ⁵ / ₁₆ " (216x110mm)	8 ¹ / ₂ " x 4 ⁵ / ₁₆ " (216x110mm)	—	8 ¹ / ₂ " x 4 ⁵ / ₁₆ " (216x110mm)
Projection	—	2 ⁷ / ₁₆ " (62mm)	2 ⁷ / ₁₆ " (62mm)	1" (25mm)	1 ¹ / ₁₆ " (46mm)
ANSI Function	01	02	03	03	11-12 Field Selectable
Cylinder Type	—	—	Rim	Rim	1 ¹ / ₄ "Mortise
Handing	—	—	Handed	—	—
Optional Trim	—	x 360L-DT x 550DT x IVES 8190	—	x 550DT x IVES 8190 10"	x 392-6

	TL-BE 	L 	L-BE 	T 	T-BE 
	Thumbturn-Blank Escutcheon Always Operable (No Cylinder)	Lever Key Locks and Unlocks	Lever Blank Escutcheon Always Operable (No Cylinder)	Thumbturn Key Locks and Unlocks (Behind C/Case)	Thumbturn Always Operable (No Cylinder) (Behind C/Case)
Product Description	3347A-TL-BE-F 3547A-TL-BE-F	3347A-L-F 3547A-L-F	3347A-L-BE-F 3547A-L-BE-F	3347A-T-F 3547A-T-F	3347A-T-BE-F 3547A-T-BE-F
Trim Description	376T-BE x 386	360L	360L-BE	360T	360T-BE
Base Size	7 ¹ / ₂ " x 1 ¹ / ₁₆ " x 7 ⁸ / ₈ " (190x43x22mm)	7 ¹ / ₂ " x 1 ¹ / ₁₆ " x 7 ⁸ / ₈ " (190x43x22mm)	7 ¹ / ₂ " x 1 ¹ / ₁₆ " x 7 ⁸ / ₈ " (190x43x22mm)	7 ¹ / ₂ " x 1 ¹ / ₁₆ " x 7 ⁸ / ₈ " (190x43x22mm)	7 ¹ / ₂ " x 1 ¹ / ₁₆ " x 7 ⁸ / ₈ " (190x43x22mm)
Grip Size	8 ¹ / ₂ " x 4 ⁵ / ₁₆ " (216x110mm)	—	—	—	—
Projection	2 ⁷ / ₁₆ " (62mm)	3" (76mm)	3" (76mm)	1 ¹ / ₁₆ " (46mm)	1 ¹ / ₁₆ " (46mm)
ANSI Function	—	08 or 09 Field Selectable	—	11 or 12 Field Selectable	—
Cylinder Type	—	1 ¹ / ₄ "Mortise	—	1 ¹ / ₄ "Mortise	—
Handing	—	Handed/Reversible	Handed/Reversible	—	—
Optional Trim	x 392-6	—	E360L-BE	—	E360T-BE

Note: 360L & 360T used on Wood Door require the 33A-WDA cover plate
376T used on Wood Door require #10-WDA cover plate

Notes

3348A/3548A Concealed Vertical Rod Device

VON DUPRIN.



3348A and 3548A for Hollow Metal single and double doors, UL listed for Panic Exit Hardware. Devices are ANSI A156.3 – 2001 Grade 1. The 3548A has a smooth mechanism case and the 3348A has grooved case. The concealed vertical rod device is non-handed except when the SS (Signal Switch) option is used. See opposite page for available outside trim and device functions.

3348A/3548A fits door stiles as narrow as 2-1/8" (44 mm). Newly designed device has a one piece center case cover.

Finishes – US3, US4, US10, US15 (35A Only) US26, US26D, US26D-AM, US28, 313 and 315.



Specifications	
Device Lengths	2' 2'8" (610 mm) Door Size - Shipped Less UL Label 3' 2'4" to 3' (660mm to 914 mm) Door Size 4' 2'8" to 4' (813 mm to 1219 mm) Door Size
Device Centerline from Finished Floor	39 ¹³ / ₁₆ " (1006mm) Standard, Adjustable from 35 ⁵ / ₈ " (905mm) to 49 ⁵ / ₈ " (1260mm)
Center Case Dimensions	8 ³ / ₁₆ " x 2 ¹³ / ₃₂ " x 1 ⁹ / ₁₆ " (208mm x 62mm x 40mm)
Mechanism Case Dimensions	2 ¹ / ₄ " x 2 ¹ / ₄ " (57mm x 57mm)
Projection	Pushbar Neutral – 3 ¹ / ₁₆ " (97 mm) Pushbar Depressed – 3 ¹ / ₁₆ " (78 mm)
Latch Bolt	Deadlocking Anti-friction Top & Bottom Bolt 3/4" (19mm) throw Deadlocking Anti-friction Top & Bottom Bolt 1 1/2" (38mm) throw
Door Undercut	3/4" (19mm)
Top & Bottom Latch	4 1/4" x 1 1/2" x 1 1/8" (114mm x 54mm x 38mm)
Vertical Rods	Round 2 piece adjustable rods Top rod adjustable from 6'8" (2027mm) to 8'4" (2533mm) Bottom rod adjustable from 35 ⁵ / ₈ " (905mm) to 49 ⁵ / ₈ " (1260mm) Extension rod kits available for doors over 8'4" (2533mm)
Fasteners & Sex Bolts (SNB)	Includes 1 3/4" (44mm) – 2 1/4" (57mm) Wood & Metal Doors #425 SNB furnished standard for end case #325 SNB furnished standard for EO (exit only device)
Electric Options	ALK Alarm Kit EL Electric Latch Retraction HD-EL Electric Latch Retraction with Hex Dogging QEL Quiet Electric Latch Retraction RX Request to Exit, WP-RX Waterproof Option LX Latchbolt Monitoring LX-RX Request to Exit / Latchbolt Monitoring RX-LC, LX-LC, LX-RX-LC Low Current Option for RX, LX, LX-RX SS Signal Switch
Miscellaneous Options	GBK Glass Bead Kit PN Pneumatic HH Hurricane SG Safety Glow SEC Security Screws SNB Sex Bolts
Dogging Feature	Hex Dogging Standard CD Cylinder Dogging LD Less Dogging
Strikes	Top – 338 – Unfinished, Bottom – 385A – Unfinished Optional Strikes

QEL
Quiet Electric Latch Retraction
• Bolt retraction via switch
• Converts exit door to push-pull operation

CD
Cylinder Dogging
• Replaces hex key dogging
• Requires standard 1 1/4" mortise cylinder

RX
Pushpad Monitor Switch
• Signals use of an opening
• SPDT switch to monitor pushpad

ALK
Alarm Exit Kit
• Unauthorized opening triggers 85-decibel horn
• Set in armed or disarmed mode by key

EL
Electric Latch Retraction
• Enables remote unlatching
• Alternative to manual dogging

DI
Dogging Indicator
• Monitor dogging status without a control panel
• Red indicator light shows visibility to dogging from over 75 feet





PN
Pneumatic Latch Retraction
• For areas where electrical devices banned
• Special linkage for mechanical or pneumatic dogging





SG
Safety Glow
• Self illuminating touchpad
• No batteries or electronics

E (E360L)
Electric Lever Trim
• Electrified remote locking/unlocking
• Fail safe & fail secure options available
• No key override

3348A/3548A Concealed Vertical Rod Device

Standard Trim

	EO	DT 	NL 	NL-OP 	TL 
	Exit Only No Outside Trim	Dummy Trim Pull when Dogged	Night Latch Key Retracts Latchbolt	Night Latch Key Retracts Latchbolt Optional Pull Required	Thumbturn Key Locks & Unlocks
Product Description	3348A-EO 3548A-EO	3348A-DT 3548A-DT	3348A-NL 3548A-NL	3348A-NL-OP 3548A-NL-OP	3348A-TL 3548A-TL
Trim Description	—	386DT	386NL	388	376T x 386
Base Size	—	7 ¹ / ₂ " x 1 ⁵ / ₈ " (190x41mm)	7 ¹ / ₂ " x 1 ⁵ / ₈ " (190x41mm)	7 ¹ / ₂ " x 1 ¹¹ / ₁₆ " (190x43mm)	7 ¹ / ₂ " x 1 ¹¹ / ₁₆ " x 7 ⁸ / ₁₆ " (190x43mmx22mm)
Grip Size	—	8 ¹ / ₂ " x 4 ⁵ / ₁₆ " (216x110mm)	8 ¹ / ₂ " x 4 ⁵ / ₁₆ " (216x110mm)	—	8 ¹ / ₂ " x 4 ⁵ / ₁₆ " (216x110mm)
Projection	—	2 ⁷ / ₁₆ " (62mm)	2 ⁷ / ₁₆ " (62mm)	1" (25mm)	1 ¹³ / ₁₆ " (46mm)
ANSI Function	01	02	03	03	11-12 Field Selectable
Cylinder Type	—	—	Rim	Rim	1 ¹ / ₄ "Mortise
Handing	—	—	Handed	—	—
Optional Trim	—	x 360L-DT x 550DT x IVES 8190	—	x 550DT x IVES 8190 10"	x 392-6

	TL-BE 	L 	L-BE 	T 	T-BE 
	Thumbturn-Blank Escutcheon Always Operable (No Cylinder)	Lever Key Locks and Unlocks	Lever Blank Escutcheon Always Operable (No Cylinder)	Thumbturn Key Locks and Unlocks (Behind C/Case)	Thumbturn Always Operable (No Cylinder) (Behind C/Case)
Product Description	3348A-TL-BE 3548A-TL-BE	3348A-L 3548A-L	3348A-L-BE 3548A-L-BE	3348A-T 3548A-T	3348A-T-BE 3548A-T-BE
Trim Description	376T-BE x 386	360L	360L-BE	360T	360T-BE
Base Size	7 ¹ / ₂ " x 1 ¹¹ / ₁₆ " x 7 ⁸ / ₁₆ " (190x43x22mm)	7 ¹ / ₂ " x 1 ¹¹ / ₁₆ " x 7 ⁸ / ₁₆ " (190x43x22mm)	7 ¹ / ₂ " x 1 ¹¹ / ₁₆ " x 7 ⁸ / ₁₆ " (190x43x22mm)	7 ¹ / ₂ " x 1 ¹¹ / ₁₆ " x 7 ⁸ / ₁₆ " (190x43x22mm)	7 ¹ / ₂ " x 1 ¹¹ / ₁₆ " x 7 ⁸ / ₁₆ " (190x43x22mm)
Grip Size	8 ¹ / ₂ " x 4 ⁵ / ₁₆ " (216x110mm)	—	—	—	—
Projection	2 ⁷ / ₁₆ " (62mm)	3" (76mm)	3" (76mm)	1 ¹³ / ₁₆ " (46mm)	1 ¹³ / ₁₆ " (46mm)
ANSI Function	—	08 or 09 Field Selectable	—	11 or 12 Field Selectable	—
Cylinder Type	—	1 ¹ / ₄ "Mortise	—	1 ¹ / ₄ "Mortise	—
Handing	—	Handed/Reversible	Handed/Reversible	—	—
Optional Trim	x 392-6	—	E360L-BE	—	E360T-BE

Note: 360L & 360T used on Wood Door require the 33A-WDA cover plate
376T used on Wood Door require #10-WDA cover plate

Notes

3348A-F/3548A-F Fire Exit Concealed Vertical Rod Device **VON DUPRIN.**



3348A-F and 3548A-F for hollow metal double doors up to 8' x 10' (2438mm x 2540mm), UL listed for Fire Exit Hardware. **See page 37 for detailed information on UL listed fire exit hardware label and door opening size information.** Devices are ANSI A156.3 – 2001 Grade 1. The 3548A-F has a smooth mechanism case and the 3348A-F has grooved case. The concealed vertical rod device is non-handed except when the SS (Signal Switch) option is used. See opposite page for available outside trim and device functions.

3348A-F/3548A-F fits door stiles as narrow as 3 1/2" (90mm). Newly designed device has a one piece center case cover.

Finishes – US3, US4, US10, US15 (35A Only) US26, US26D, US26D-AM, US28, 313 and 315.

Specifications	
Device Lengths	2' 2' (610 mm) Door Size - Shipped Less UL Label 3' 2'4" to 3' (660mm to 914 mm) Door Size 4' 2'8" to 4' (813 mm to 1219 mm) Door Size
Device Centerline from Finished Floor	39 13/16" (1006mm) Standard, Adjustable from 35 5/8" (905mm) to 49 5/8" (1260mm)
Center Case Dimensions	8 3/16" x 2 13/32" x 1 9/16" (208mm x 62mm x 40mm)
Mechanism Case Dimensions	2 1/4" x 2 1/4" (57mm x 57mm)
Projection	Pushbar Neutral – 3 13/16" (97 mm) Pushbar Depressed – 3 1/16" (78 mm)
Latch Bolt	Deadlocking Anti-friction Top Bolt 3/4" (19mm) throw Deadlocking Anti-friction Bottom Bolt 1 1/2" (38mm) throw
Door Undercut	3/4" (19mm)
Top & Bottom Latch	4 1/4" x 1 1/2" x 1 1/8"
Vertical Rods	Round 2 piece adjustable rods Top rod adjustable from 6'8" (2027mm) to 8'4" (2533mm) Bottom rod adjustable from 35 5/8" (905mm) to 49 5/8" (1260mm) Extension rod kits available for doors over 8'4" (2533mm)
Fasteners & Sex Bolts (SNB)	Includes 1 3/4" (44mm) – 2 1/4" (57mm) Wood & Metal Doors #425 SNB furnished standard for end case #325 SNB furnished standard for EO (exit only device)
Electric Options	ALK Alarm Kit EL Electric Latch Retraction HD-EL Electric Latch Retraction with Hex Dogging QEL Quiet Electric Latch Retraction RX Request to Exit, WP-RX Waterproof Option LX Latchbolt Monitoring LX-RX Request to Exit / Latchbolt Monitoring RX-LC, LX-LC, LX-RX-LC Low Current Option for RX, LX, LX-RX SS Signal Switch
Miscellaneous Options	GBK Glass Bead Kit PN Pneumatic HH Hurricane SG Safety Glow SEC Security Screws SNB Sex Bolts
Strikes	Top – 338 – Unfinished, Bottom – 385A – Unfinished Optional Strikes

QEL
Quiet Electric Latch Retraction
• Bolt retraction via switch
• Converts exit door to push-pull operation

RX
Pushpad Monitor Switch
• Signals use of an opening
• SPDT switch to monitor pushpad

EL
Electric Latch Retraction
• Enables remote unlatching
• Alternative to manual dogging





ALK
Alarm Exit Kit
• Unauthorized opening triggers 85-decibel horn
• Set in armed or disarmed mode by key





PN
Pneumatic Latch Retraction
• For areas where electrical devices banned
• Special linkage for mechanical or pneumatic dogging

SG
Safety Glow
• Self illuminating touchpad
• No batteries or electronics

E (E360L)
Electric Lever Trim
• Electrified remote locking/unlocking
• Fail safe & fail secure options available
• No key override

Standard Trim

	EO	DT 	NL 	NL-OP 	TL 
	Exit Only No Outside Trim	Dummy Trim Pull when Dogged (Not recommended for Fire Device)	Night Latch Key Retracts Latchbolt	Night Latch Key Retracts Latchbolt Optional Pull Required	Thumbturn Key Locks & Unlocks
Product Description	3348A-EO-F 3548A-EO-F	3348A-DT-F 3548A-DT-F	3348A-NL-F 3548A-NL-F	3348A-NL-OP-F 3548A-NL-OP-F	3348A-TL-F 3548A-TL-F
Trim Description	—	386DT	386NL	388	376T x 386
Base Size	—	7 ¹ / ₂ " x 1 ⁵ / ₈ " (190x41mm)	7 ¹ / ₂ " x 1 ⁵ / ₈ " (190x41mm)	7 ¹ / ₂ " x 1 ¹ / ₁₆ " (190x43mm)	7 ¹ / ₂ " x 1 ¹ / ₁₆ " x 7 ⁸ / ₈ " (190x43mmx22mm)
Grip Size	—	8 ¹ / ₂ " x 4 ⁵ / ₁₆ " (216x110mm)	8 ¹ / ₂ " x 4 ⁵ / ₁₆ " (216x110mm)	—	8 ¹ / ₂ " x 4 ⁵ / ₁₆ " (216x110mm)
Projection	—	2 ⁷ / ₁₆ " (62mm)	2 ⁷ / ₁₆ " (62mm)	1" (25mm)	1 ¹ / ₁₆ " (46mm)
ANSI Function	01	02	03	03	11-12 Field Selectable
Cylinder Type	—	—	Rim	Rim	1 ¹ / ₄ "Mortise
Handing	—	—	Handed	—	—
Optional Trim	—	x 360L-DT x 550DT x IVES 8190	—	x 550DT x IVES 8190 10"	x 392-6

	TL-BE 	L 	L-BE 	T 	T-BE 
	Thumbturn-Blank Escutcheon Always Operable (No Cylinder)	Lever Key Locks and Unlocks	Lever Blank Escutcheon Always Operable (No Cylinder)	Thumbturn Key Locks and Unlocks (Behind C/Case)	Thumbturn Always Operable (No Cylinder) (Behind C/Case)
Product Description	3348A-TL-BE-F 3548A-TL-BE-F	3348A-L-F 3548A-L-F	3348A-L-BE-F 3548A-L-BE-F	3348A-T-F 3548A-T-F	3348A-T-BE-F 3548A-T-BE-F
Trim Description	376T-BE x 386	360L	360L-BE	360T	360T-BE
Base Size	7 ¹ / ₂ " x 1 ¹ / ₁₆ " x 7 ⁸ / ₈ " (190x43x22mm)	7 ¹ / ₂ " x 1 ¹ / ₁₆ " x 7 ⁸ / ₈ " (190x43x22mm)	7 ¹ / ₂ " x 1 ¹ / ₁₆ " x 7 ⁸ / ₈ " (190x43x22mm)	7 ¹ / ₂ " x 1 ¹ / ₁₆ " x 7 ⁸ / ₈ " (190x43x22mm)	7 ¹ / ₂ " x 1 ¹ / ₁₆ " x 7 ⁸ / ₈ " (190x43x22mm)
Grip Size	8 ¹ / ₂ " x 4 ⁵ / ₁₆ " (216x110mm)	—	—	—	—
Projection	2 ⁷ / ₁₆ " (62mm)	3" (76mm)	3" (76mm)	1 ¹ / ₁₆ " (46mm)	1 ¹ / ₁₆ " (46mm)
ANSI Function	—	08 or 09 Field Selectable	—	11 or 12 Field Selectable	—
Cylinder Type	—	1 ¹ / ₄ "Mortise	—	1 ¹ / ₄ "Mortise	—
Handing	—	Handed/Reversible	Handed/Reversible	—	—
Optional Trim	x 392-6	—	E360L-BE	—	E360T-BE

Note: 360L & 360T used on Wood Door require the 33A-WDA cover plate
376T used on Wood Door require #10-WDA cover plate

Notes

3349A/3549A Concealed Vertical Cable Device



3349A and 3549A for all types of single and double doors, UL listed for Panic Exit Hardware. Devices are ANSI A156.3 – 2001 Grade 1. The 3549A has a smooth mechanism case and the 3349A has grooved case. The concealed vertical cable device is non-handed except when the SS (Signal Switch) option is used. See opposite page for available outside trim and device functions.

3349A/3549A fits door stiles as narrow as 2-1/8" (44 mm). Newly designed device has a one piece center case cover.

Finishes – US3, US3A, US4, US4A, US10, US15 (3549 Only), US26, US26D, US26D-AM Antimicrobial, US28, 313, 315 and 643E.



Specifications	
Device Lengths	2' 2' (610mm) Door Size - Shipped Less UL Label 3' 2'2" to 3' (660mm to 914 mm) Door Size 4' 2'8" to 4' (813 mm to 1219 mm) Door Size
Device Centerline from Finished Floor	39 ⁵ / ₈ " (1006mm) Standard
Center Case Dimensions	8 ³ / ₁₆ " x 2 ¹³ / ₃₂ " x 1 ⁹ / ₁₆ " (208mm x 62mm x 40mm)
Mechanism Case Dimensions	2 ¹ / ₄ " x 2 ¹ / ₄ " (57mm x 57mm)
Projection	Pushbar Neutral – 3 ¹³ / ₁₆ " (97 mm) Pushbar Depressed – 3 ¹ / ₁₆ " (78 mm)
Latch Bolt	Deadlocking Anti-friction Top & Bottom Bolt 1/2" (13mm) throw
Door Undercut	3/4" (19mm) Maximum - 24231516 Spacer Block Kit needed for 3/4" undercut
Top & Bottom Latch	5 ¹³ / ₁₆ " x 1 ¹ / ₄ " x 1 ⁷ / ₁₆ " (147mm x 32mm x 37mm)
Vertical Cables	7/32" (6mm) Diameter Stainless Steel Cables
Fasteners & Sex Bolts (SNB)	Includes 1 ³ / ₄ " (44mm) – 2 ¹ / ₄ " (57mm) Metal Doors #425 SNB furnished standard for end case #325 SNB furnished standard for EO (exit only device)
Electric Options	ALK Alarm Kit EL Electric Latch Retraction HD-EL Electric Latch Retraction with Hex Dogging QEL Quiet Electric Latch Retraction RX Request to Exit, WP-RX Waterproof Option *LX Latchbolt Monitoring *LX-RX Request to Exit / Latchbolt Monitoring *RX-LC, LX-LC, LX-RX-LC Low Current Option for RX, LX, LX-RX SS Signal Switch
Miscellaneous Options	GBK Glass Bead Kit PL Pullman Latch PN Pneumatic INS-2/INS-4 Insulclad Kits 1/2" / 1/4" Panels LBL Less Bottom Latch SG Safety Glow SEC Security Screws SNB Sex Bolts
Dogging Feature	Hex Dogging Standard CD Cylinder Dogging LD Less Dogging
Strikes	Top – 249 Bottom – 349

QEL
Quiet Electric Latch Retraction
• Bolt retraction via switch
• Converts exit door to push-pull operation

CD
Cylinder Dogging
• Replaces hex key dogging
• Requires standard 1¹/₄" mortise cylinder

EL
Electric Latch Retraction
• Enables remote unlatching
• Alternative to manual dogging

RX
Pushpad Monitor Switch
• Signals use of an opening
• SPDT switch to monitor pushpad

PN
Pneumatic Latch Retraction
• For areas where electrical devices banned
• Special linkage for mechanical or pneumatic dogging

ALK
Alarm Exit Kit
• Unauthorized opening triggers 85-decibel horn
• Set in armed or disarmed mode by key



E (E360L)
Electric Lever Trim
• Electrified remote locking/unlocking
• Fail safe & fail secure options available
• No key override





DI
Dogging Indicator
• Monitor dogging status without a control panel
• Red indicator light shows visibility to dogging from over 75 feet

SG
Safety Glow
• Self illuminating touchpad
• No batteries or electronics

*For 33/3549A devices, LX switch monitors trim input or electric dogging of EL/QEL devices. LX switch does not monitor latchbolt condition.

Standard Trim

	EO	DT	NL	NL-OP
				
	Exit Only	Dummy Trim Pull when Dogged	Night Latch Key Retracts Latchbolt	Night Latch Key Retracts Latchbolt Optional Pull Required
Product Description	3349A-EO 3549A-EO	3349A-DT 3549A-DT	3349A-NL 3549A-NL	3349A-NL-OP 3549A-NL-OP
Trim Description	—	386DT	386NL	388
Base Size	—	7 ¹⁵ / ₃₂ " x 1 ⁵ / ₈ " (190x41mm)	7 ¹⁵ / ₃₂ " x 1 ⁵ / ₈ " (190x41mm)	7 ¹ / ₂ " x 1 ¹¹ / ₁₆ " (190x43mm)
Grip Size	—	8 ¹ / ₂ " x 4 ⁵ / ₁₆ " (216x110mm)	8 ¹ / ₂ " x 4 ⁵ / ₁₆ " (216x110mm)	—
Projection	—	2 ⁷ / ₁₆ " (62mm)	2 ⁷ / ₁₆ " (62mm)	1" (25mm)
ANSI Function	01	02	03	03
Cylinder Type	—	—	Rim	Rim
Handing	—	—	Handed	—
Optional Trim	—	x 360L-DT x 550DT x IVES 8190	—	x 550DT x IVES 8190 10"

	L	L-BE	T	T-BE
				
	Lever Key Locks and Unlocks	Lever Blank Escutcheon Always Operable (No Cylinder)	Thumbturn Key Locks and Unlocks (Behind C/Case)	Thumbturn Always Operable (No Cylinder) (Behind C/Case)
Product Description	3349A-L 3549A-L	3349A-L-BE 3549A-L-BE	3349A-T 3549A-T	3349A-T-BE 3549A-T-BE
Trim Description	360L	360L-BE	360T	360T-BE
Base Size	7 ¹ / ₂ " x 1 ¹¹ / ₁₆ " x 7 ⁷ / ₈ " (190x43x22mm)	7 ¹ / ₂ " x 1 ¹¹ / ₁₆ " x 7 ⁷ / ₈ " (190x43x22mm)	7 ¹ / ₂ " x 1 ¹¹ / ₁₆ " x 7 ⁷ / ₈ " (190x43x22mm)	7 ¹ / ₂ " x 1 ¹¹ / ₁₆ " x 7 ⁷ / ₈ " (190x43x22mm)
Grip Size	—	—	—	—
Projection	3" (76mm)	3" (76mm)	1 ¹³ / ₁₆ " (46mm)	1 ¹³ / ₁₆ " (46mm)
ANSI Function	08 or 09 Field Selectable	—	11 or 12 Field Selectable	—
Cylinder Type	1 ¹ / ₄ " Mortise	—	1 ¹ / ₄ " Mortise	—
Handing	Handed / Reversible	Handed / Reversible	—	—
Optional Trim	—	E360L-BE	—	E360T-BE

Standard Door Opening Height	
Feet	Inches
6'8"	80"
7'	84"
8'	96"
9'	108"
10'	120"

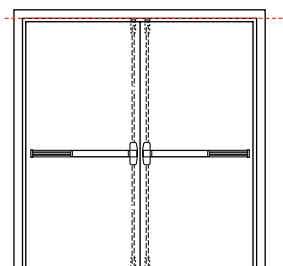

Door Opening Height

is measured from finished floor to frame rabbet on door side.

See table on left for standard offering.

Note: Non-standard sizes available with extended lead time. Consult Customer Care for more information 1-877-671-7011.

3349A-F/3549A-F Fire Exit Concealed Vertical Cable Device



3349A-F and 3549A-F for all types of double doors up to 8' x 10' (2438mm x 2540mm), UL listed for Fire Exit Hardware. **See page 37 for detailed information on UL listed fire exit hardware label and door opening size information.** Devices are ANSI A156.3 – 2001 Grade 1. The 3549A-F has a smooth mechanism case and the 3349A-F has grooved case. The concealed vertical cable device is non-handed except when the SS (Signal Switch) option is used. See opposite page for available outside trim and device functions.

3349A-F/3529A-F fits door stiles as narrow as 3 1/2" (90mm). Newly designed device has a one piece center case cover.

Finishes – US3, US3A, US4, US4A, US10, US15 (3549 Only), US26, US26D, US26D-AM Antimicrobial, US28, 313, 315 and 643E.



Specifications

Device Lengths	2' 2' (610mm) Door Size - Shipped Less UL Label 3' 2'2" to 3' (660mm to 914 mm) Door Size 4' 2'8" to 4' (813 mm to 1219 mm) Door Size
Device Centerline from Finished Floor	39 5/8" (1006mm) Standard
Center Case Dimensions	8 3/16" x 2 13/32" x 1 9/16" (208mm x 62mm x 40mm)
Mechanism Case Dimensions	2 1/4" x 2 1/4" (57mm x 57mm)
Projection	Pushbar Neutral – 3 13/16" (97 mm) Pushbar Depressed – 3 1/16" (78 mm)
Latch Bolt	Deadlocking Anti-friction Top & Bottom Bolt 1 1/2" (13mm) throw
Door Undercut	3/4" (19mm) Maximum - 24231516 Spacer Block Kit needed for 3/4" undercut
Top & Bottom Latch	5 13/16" x 1 1/4" x 1 7/16" (147mm x 32mm x 37mm)
Vertical Cables	7/32" (6mm) Diameter Stainless Steel Cables
Fasteners & Sex Bolts (SNB)	Includes 1 3/4" (44mm) – 2 1/4" (57mm) Wood & Metal Doors #425 SNB furnished standard for end case #325 SNB furnished standard for EO (exit only device)
Electric Options	ALK Alarm Kit EL Electric Latch Retraction HD-EL Electric Latch Retraction with Hex Dogging QEL Quiet Electric Latch Retraction RX Request to Exit, WP-RX Waterproof Option *LX Latchbolt Monitoring *LX-RX Request to Exit / Latchbolt Monitoring *RX-LC, LX-LC, LX-RX-LC Low Current Option for RX, LX, LX-RX SS Signal Switch
Miscellaneous Options	GBK Glass Bead Kit PN Pneumatic LBL Less Bottom Latch SG Safety Glow SEC Security Screws SNB Sex Bolts
Strikes	Top – 249 Bottom – 349

QEL
Quiet Electric Latch Retraction

- Bolt retraction via switch
- Converts exit door to push-pull operation

RX
Pushpad Monitor Switch

- Signals use of an opening
- SPDT switch to monitor pushpad

EL
Electric Latch Retraction

- Enables remote unlatching
- Alternative to manual dogging

ALK
Alarm Exit Kit

- Unauthorized opening triggers 85-decibel horn
- Set in armed or disarmed mode by key

PN
Pneumatic Latch Retraction

- For areas where electrical devices banned
- Special linkage for mechanical or pneumatic dogging

SG
Safety Glow



- Self illuminating touchpad
- No batteries or electronics





E (E360L)
Electric Lever Trim

- Electrified remote locking/unlocking
- Fail safe & fail secure options available
- No key override

*For 33/3549A devices, LX switch monitors trim input or electric dogging of EL/QEL devices. LX switch does not monitor latchbolt condition.

Standard Trim

	EO	DT	NL	NL-OP
				
	Exit Only	Dummy Trim Pull when Dogged	Night Latch Key Retracts Latchbolt	Night Latch Key Retracts Latchbolt Optional Pull Required
Product Description	3349A-EO 3549A-EO	3349A-DT 3549A-DT	3349A-NL 3549A-NL	3349A-NL-OP 3549A-NL-OP
Trim Description	—	386DT	386NL	388
Base Size	—	7 ¹⁵ / ₃₂ " x 1 ⁵ / ₈ " (190x41mm)	7 ¹⁵ / ₃₂ " x 1 ⁵ / ₈ " (190x41mm)	7 ¹ / ₂ " x 1 ¹¹ / ₁₆ " (190x43mm)
Grip Size	—	8 ¹ / ₂ " x 4 ⁵ / ₁₆ " (216x110mm)	8 ¹ / ₂ " x 4 ⁵ / ₁₆ " (216x110mm)	—
Projection	—	2 ⁷ / ₁₆ " (62mm)	2 ⁷ / ₁₆ " (62mm)	1" (25mm)
ANSI Function	01	02	03	03
Cylinder Type	—	—	Rim	Rim
Handing	—	—	Handed	—
Optional Trim	—	x 360L-DT x 550DT x IVES 8190	—	x 550DT x IVES 8190 10"

	L	L-BE	T	T-BE
				
	Lever Key Locks and Unlocks	Lever Blank Escutcheon Always Operable (No Cylinder)	Thumbturn Key Locks and Unlocks (Behind C/Case)	Thumbturn Always Operable (No Cylinder) (Behind C/Case)
Product Description	3349A-L 3549A-L	3349A-L-BE 3549A-L-BE	3349A-T 3549A-T	3349A-T-BE 3549A-T-BE
Trim Description	360L	360L-BE	360T	360T-BE
Base Size	7 ¹ / ₂ " x 1 ¹¹ / ₁₆ " x 7 ⁷ / ₈ " (190x43x22mm)	7 ¹ / ₂ " x 1 ¹¹ / ₁₆ " x 7 ⁷ / ₈ " (190x43x22mm)	7 ¹ / ₂ " x 1 ¹¹ / ₁₆ " x 7 ⁷ / ₈ " (190x43x22mm)	7 ¹ / ₂ " x 1 ¹¹ / ₁₆ " x 7 ⁷ / ₈ " (190x43x22mm)
Grip Size	—	—	—	—
Projection	3" (76mm)	3" (76mm)	1 ¹³ / ₁₆ " (46mm)	1 ¹³ / ₁₆ " (46mm)
ANSI Function	08 or 09 Field Selectable	—	11 or 12 Field Selectable	—
Cylinder Type	1 ¹ / ₄ " Mortise	—	1 ¹ / ₄ " Mortise	—
Handing	Handed / Reversible	Handed / Reversible	—	—
Optional Trim	—	E360L-BE	—	E360T-BE

Standard Door Opening Height	
Feet	Inches
6'8"	80"
7'	84"
8'	96"
9'	108"
10'	120"

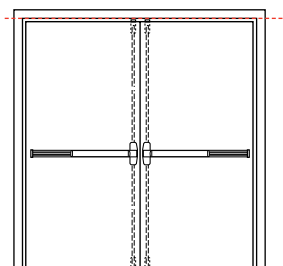

Door Opening Height

is measured from finished floor to frame rabbet on door side.

See table on left for standard offering.

Note: Non-standard sizes available with extended lead time. Consult Customer Care for more information 1-877-671-7011.

Trim Operation Lever

Standard



Key locks and unlocks lever. e.g., 360L (Classroom)

Night Latch



Key unlocks lever, lever is relocked when key is removed. Use NL suffix, e.g. 360LNL. (Storeroom)

Blank Escutcheon

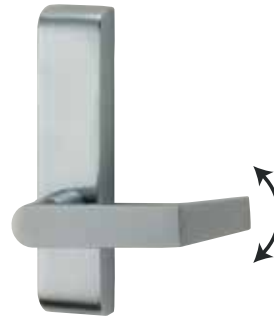

Lever always active. Use BE suffix, e.g., 360L-BE. (Passage)

Dummy



Lever is rigid for pull operation. Use DT suffix, e.g., 360L-DT.

374T/376T Series Thumbturn Control



Standard operation, key locks and unlocks thumbturn. Optional operation, key unlocks thumbturn, re-locks when key is removed. This operation is created by changing the cylinder plate included with control. Use 1¼" mortise cylinder with a straight cam. Schlage cam reference B502-191. Not available for 3349/3549 devices.

E360 Series Controls

The E360 series controls provide the same choice of lever or thumbturn control of the 33A/35A Series exit device. Additionally, these trims have the advantage of being electrically controllable by a remote switching device, an access control system or automatic fire alarm system. The trim operates with a rotary solenoid that controls the locking cam the same way the standard cylinder works. These trims are available as -BE (Blank Escutcheon) function only. These trims are designed for use with the rim, surface vertical and concealed vertical 33A/35A Series exit device. No cylinder override.

Options:

- Available in all device finishes
- 24VDC Solenoid (.5 amp draw)
- Fail Safe (FS) or Fail Secure (FSE)
- Blank Escutcheon (BE) only

To order, specify:

1. FSE or FS
2. Handing - (Lever control) field reversible
3. EPT-2/EPT-10 Power Transfer or Electric Hinge will be used

Lever Styles



01



02

Knurling available



03*

Knurling available



05



06*

Default lever
Knurling available



07



12

(Handed)



16

(Omega)



17*

Knurling available



18



ACC
(Accent)
(Handed)



AST
(Asti)
(Handed)



MER
(Merano)
(Handed)



STA
(St. Annes)
(Handed)



LAT*
Latitude







LON*
Longitude





*Available in Stainless Steel - specify SS when ordering

33A/35A Optional Trim

Optional Trim

					
	Lever Pull when dogged	Night Latch Key Retracts Latchbolt	Night Latch Key Retracts Latchbolt	Thumbturn Key Locks & Unlocks	Thumbturn Key Locks & Unlocks
Trim Description	360L-DT	388 x 550DT	388 x IVES 8190 10"	360T x 550DT	360T x IVES 8190 10"
Base Size	7½" x 1⅞" x 7/8" (190x43mmx22mm)	7½" x 1⅞" x 7/8" (190x43mm)	7½" x 1⅞" x 7/8" (190x43mm)	7½" x 1⅞" x 7/8" (190x43mmx22mm)	7½" x 1⅞" x 7/8" (190x43mmx22mm)
Grip Size	—	10" center to center	10" center to center	10" center to center	10" center to center
Projection	3" (76mm)	1" (25mm)	1" (25mm)	1⅜" (46mm)	1⅜" (46mm)
ANSI Function	02	03	03	11/12 Field Selectable	11/12 Field Selectable
Cylinder Type	—	Rim	Rim	1¼" Mortise	1¼" Mortise
Handing	Handed / Reversible	—	—	—	—

Optional Trim

					
	Thumbturn-Blank Escutcheon Always Operable (No Cylinder)	Thumbturn-Blank Escutcheon Always Operable (No Cylinder)	Thumbturn Key Locks & Unlocks	Thumbturn-Blank Escutcheon Always Operable (No Cylinder)	Offset Pull
Trim Description	360T-BE x 550 DT	360T-BE x 8190 10"	374T/376T x 8190 10"	374T-BE/376T-BE x 8190 10"	392-6
Base Size	7½" x 1⅞" x 7/8" (190x43mmx22mm)	7½" x 1⅞" x 7/8" (190x43mmx22mm)	7½" x 1⅞" x 7/8" (190x43mmx22mm)	7½" x 1⅞" x 7/8" (190x43mmx22mm)	7" x 3½" x ¾"
Grip Size	1⅞" center to center	1" center to center	8½" x 4⅝" (216x110mm)	8½" x 4⅝" (216x110mm)	6¼" center to center
Projection	1⅜" (46mm)	1⅜" (46mm)	1⅜" (46mm)	1⅜" (46mm)	2¼"
ANSI Function	—	—	11-12 Field Selectable	—	—
Cylinder Type	—	—	1¼" Mortise	—	—
Handing	—	—	—	—	—

Note: 360L & 360T used on Wood Door require the 33A-WDA cover plate
376T used on Wood Door require #10-WDA cover plate

Notes

Strike Application/Minimum Stile

DEVICE TYPE	STANDARD SINGLE DOOR		STANDARD DOUBLE DOOR		OPTIONAL SINGLE DOOR		OPTIONAL DOUBLE DOOR	
	STRIKE	STILE	STRIKE W/MULLION	STILE	STRIKE	STILE	STRIKE W/MULLION	STILE
33A 35A	1439	1¾" (44mm)	1408 x 5754	1¾" (44mm)	299 1410 1606	2¾" (70mm) 1¾" (44mm) 2½" (64mm)	299 x 5654 299 x 4954 1606 x 1654	2⅝" (67mm) 3⅝" (84mm) 2¾" (70mm)
3327A 3527A	266 (Top) 304L (Bottom) 248-L (Bottom)	1¾" (44mm)	266 (Top) 304L (Bottom) 248-L (Bottom)	1¾" (44mm)	299 (Top) 385A (Bottom) 260U (Top) 385A (Bottom)	3⅞" (79mm) 2⅞" (54mm)	299 (Top) 385A (Bottom) 260U (Top) 385A (Bottom)	3⅞" (79mm) 2⅞" (54mm)
3327A-F 3527A-F	—	—	299F (Top) 304L (Bottom)	2⅜" (56mm)	—	—	—	—
3327A-LBR-F	—	—	499F (Top) (Req. Auxiliary Fire Latch)	3⅝" (92mm)	—	—	—	—
3347A 3547A 3348A 3548A	338 (Top) 385 (Bottom)	2½" (64mm)	338 (Top) 385 (Bottom)	1¾" (44mm)	304L (Bottom)	2½" (64mm)	304L (Bottom)	2½" (64mm)
3347A-F 3547A-F 3348A-F 3548A-F	—	—	338 (Top) 385A (Bottom)	3½" (89mm)	—	—	304L (Bottom)	3½" (89mm)
3347A-LBR 3547A-LBR 3348A-LBR 3548A-LBR	338 (Top)	2½" (64mm)	338 (Top)	2½" (64mm)	—	—	—	—
3347A-LBR-F 3547A-LBR-F	—	—	338 (Top)	3⅝" (92mm)	—	—	—	—
3349A 3549A	249 (Top) 349 (Bottom)	2½" (64mm)	249 (Top) 349 (Bottom)	1¾" (44mm)	—	—	—	—
3349A-F 3549A-F	—	—	249 (Top) 349 (Bottom)	3½" (89mm)	—	—	—	—
3349A-LBR 3549A-LBR	249 (Top) 349 (Bottom)	2½" (64mm)	249 (Top) 349 (Bottom)	2½" (64mm)	—	—	—	—
3349A-LBR-F 3549A-LBR-F	—	—	249 (Top) 349 (Bottom)	3⅝" (92mm)	—	—	—	—

Strikes for rim devices

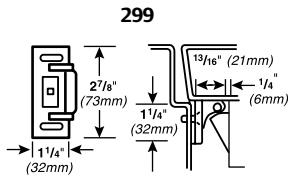

Projection 1 3/16" (21mm)

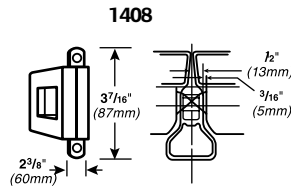

One per pair of doors - use with 5754 Mullion only

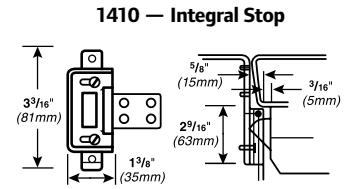

Projection 1/2" (13mm)

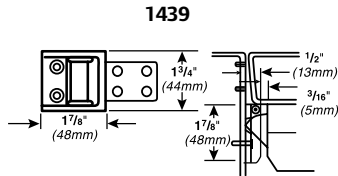

Projection 1/2" (13mm)

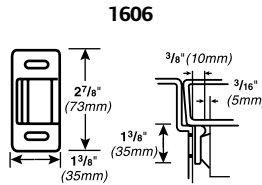

Projection 3/8" (10mm)

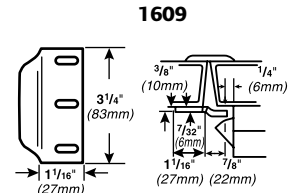

For rim/vertical rod combination -not fire rated

Strikes for vertical cable devices

249 - Top Strike

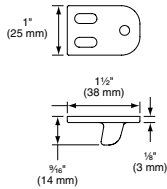

Projection 9/16" (14mm)

349 - Bottom Strike

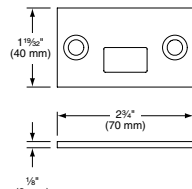

Projection 1/8" (3mm)

Strikes for vertical rod devices

260U-Flush Transom Only

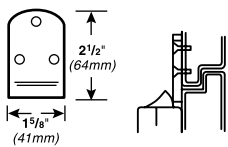

Projection 3/8" (10mm)

266

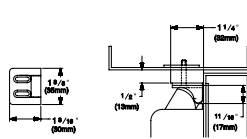

Projection 1 1/4" (32mm)

299

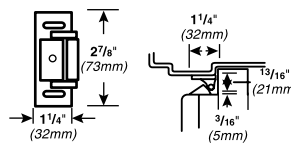

Projection 1 3/16" (21mm)

299F

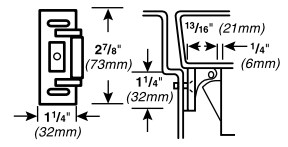

Projection 1 3/16" (21mm)

304L

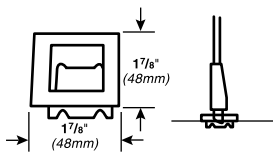

Mortise 1 3/16" (21mm)

338

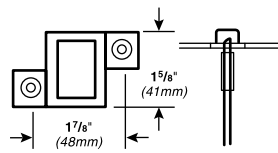

Mortise 5/8" (16mm)

385A

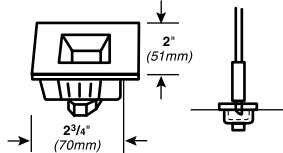

Mortise 2 1/2" (64mm)

499F

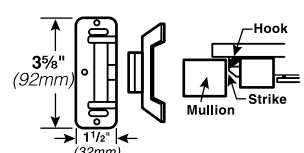

Projection 1 9/16" (21mm)

ANSI Function, Grade & Type

Function	Grade 1, Type 4	Grade 1, Type 5	Grade 1, Type 6, 7 & 8	
01	33AEO 35AEO	3327A-EO 3327A-EO-F 3527A-EO 3527A-EO-F	3347A-EO 3347A-EO-F 3348A-EO 3348A-EO-F 3349A-EO 3349A-EO-F	3547A-EO 3547A-EO-F 3548A-EO 3548A-EO-F 3549A-EO 3549A-EO-F
02	33A-DT 35A-DT	3327A-DT 3527A-DT	3347A-DT 3348A-DT 3349A-DT	3547A-DT 3548A-DT 3549A-DT
03	33A-NL 33A-NL-OP 35A-NL 35A-NL-OP	3327A-NL-OP 3527A-NL-OP 3327A-NL-OP-F 3527A-NL-OP-F 3527A-NL 3327A-NL-F 3527A-NL 3527A-NL-F	3347A-NL-OP 3347A-NL-OP-F 3348A-NL-OP 3348A-NL-OP-F 3347A-NL 3347-NL-F 3348-NL 3348-NL-F 3349A-NL-OP 3349A-NL-OP-F 3349A-NL 3349A-NL-F	3547A-NL-OP 3547A-NL-OP-F 3548A-NL-OP 3548A-NL-OP-F 3547A-NL 3547-NL-F 3548-NL 3548-NL-F 3549A-NL-OP 3549A-NL-OP-F 3549A-NL 3549A-NL-F
08-09	33A-L 35A-L	3327A-L 3327A-L-F 3527A-L 3527A-L-F	3347A-L 3347A-L-F 3348A-L 3348A-L-F 3349A-L 3349A-L-F	3547A-L 3547A-L-F 3548A-L 3548A-L-F 3549A-L 3549A-L-F
11-12	33A-TL 35A-TL	3327A-TL 3327A-TL-F 3527A-TL 3527A-TL-F	3347A-TL 3347A-TL-F 3348A-TL 3348A-TL-F	3547A-TL 3547A-TL-F 3548A-TL 3548A-TL-F

Dimensions

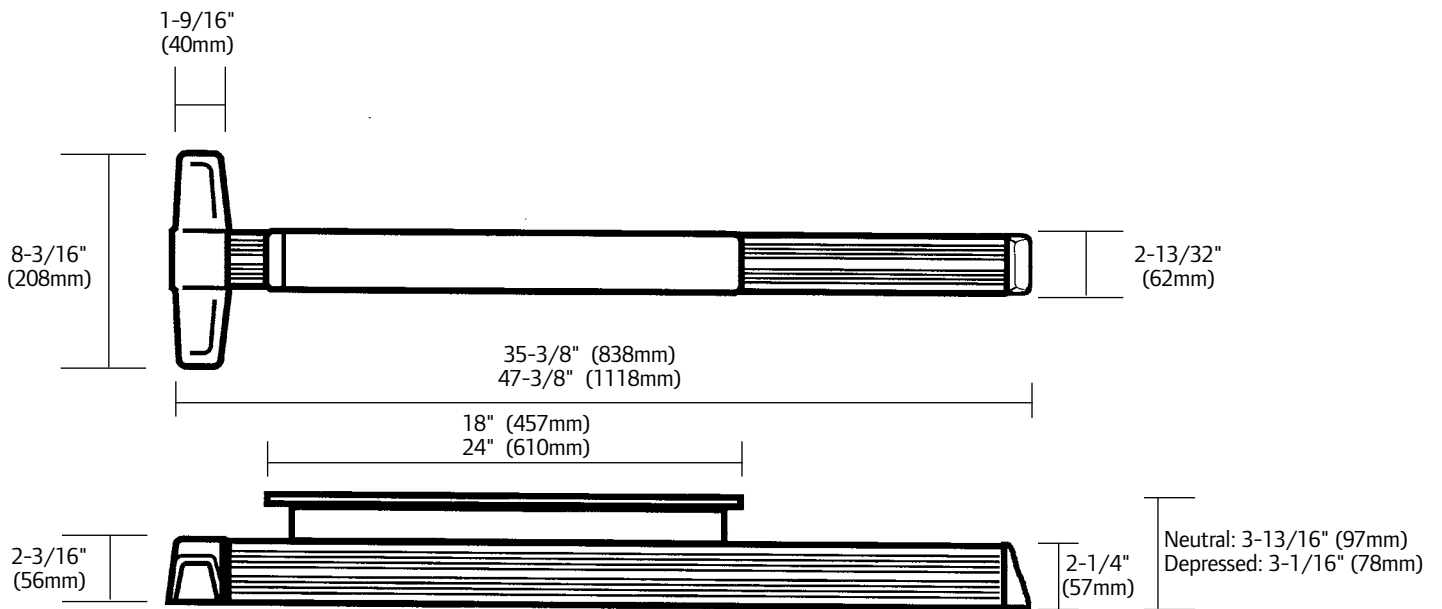

ALK Alarm Kit

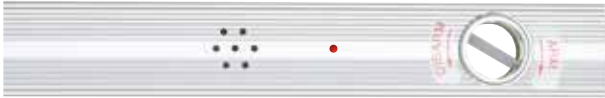

The ALK battery alarm kit is a simple yet effective way to deter unauthorized use of an opening. While the exit device is still a means of egress, the ALK kit contains an internal horn. When the touch bar is depressed, the horn sounds to provide an audible means of signaling that the opening has been violated. The alarm kit can be armed or disarmed by key. Thus allowing the exit device to be set in an armed or disarmed mode. The horn is rated at 85 decibel.

The key switch uses a standard 1¼" (32mm) mortise cylinder with a straight cam (Schlage Cam reference B502-191). The unit operates on one standard 9-volt alkaline battery. When the battery is weak, the horn will emit an intermittent low battery alert signal.

Also can be powered using the PS902 Power Supply. See PS902 for additional information. Alarm kits are available with a choice of two switch kits, RX or LX. RX monitors the touchpad and is furnished standard. LX optional latch bolt monitoring is recommended for use with surface vertical rod exit devices. Specify ALK-LX.

The ALK is available in two styles, 33A/99ALK, grooved cover and 35A/98ALK, smooth cover.

The ALK includes "EMERGENCY EXIT ONLY. ALARM WILL SOUND" decal for application on door, or the RSS push bar trim can be used instead of the door decal, specify RSS push bar trim.

The External Inhibit comes standard on Von Duprin exit devices. External Inhibit (EI) allows for the use of external switch to be used to arm, disarm and reset the alarm. Auto Reset (AR) is an available option that rearms the alarm after a preset time. AR is available in three factory set times – 1½, 3 or 4½ minutes.

To order, specify:

1. Auto Reset – ALK-AR3

When the ALK is used, standard dogging is removed. If cylinder dogging is required for 3' or 4' doors the ALK can be moved to the hinge side of the device and standard cylinder dogging can be added.

To order, specify:

1. Standard, 33A ALK
2. Cylinder Dogging, CD33A ALK

Minimum Door Sizes

Device	3' (914mm) Length	4' (1219mm) Length
33A/35A	2'9" (838mm)	3'3" (991mm)
3327A/3527A	2'8" (813mm)	3'2" (966mm)
3347A/3347A-F 3547A/3547A-F	2'8" (813mm)	3'2" (966mm)
3348A/3348A-F 3548A/3548A-F	2'8" (813mm)	3'2" (966mm)

RX Request to Exit



The RX feature is used to signal the use of an opening. This device is equipped with one internal SPDT switch which monitors the pushpad.

The device can be connected to a security console, or may be used as a single door alarm when used with a horn and power supply. A continuous current electric transfer must be used for transferring power from the frame to the door.

The RX switch option should not be used to control a load, but as a signalling switch (0.5 amps. resistive maximum). The RX switch is available in a low current (LC) switch. Most commonly used in computer operated monitoring systems.

To order, specify:

1. Standard – Use prefix RX, example RX33AEO
2. Low Current – Use prefix RX-LC, example RX-LC35AEO

RX2 Double Request to Exit

The RX2 feature uses 2 RX switches.

To order, specify:

1. Standard – Use prefix RX2, example RX233AEO

LX Latch Bolt Monitoring



The LX feature is used to signal the use of an opening. This device is equipped with one internal SPDT switch which monitors the latch bolt. The device can be connected to a security console, or may be used as a single door alarm when used with a horn and power supply. A continuous current electric transfer must be used for transferring power from the frame to the door.

The LX switch option should not be used to control a load, but as a signalling switch (0.5 amps. resistive maximum).

The LX switch is available in a low current (LC) switch. Most commonly used in computer operated monitoring systems.

To order, specify:

1. Standard – Use prefix LX, example LX33AEO
2. Low Current – Use prefix LX-LC, example LX-LC35AEO

Electrical Rating for all Switches:

- Standard – 2 Amp maximum @ 24VDC
- Low Current (LC) – below 50 Milliamps @ 24VDC

Note: All Switches can be either factory or field installed

QEL Quiet Electric Latch Retraction

The QEL feature allows for the remote unlatching of exit devices. A control station operator can flip a switch to retract the latch bolt and immediately change an exit door to push-pull operation. Different than the popular EL, the QEL quiet operation is achieved using an electric drive motor which retracts the latch bolt either momentary unlatching or for extended periods of time. This feature is an alternative to manual dogging.

QEL devices are also useful with automatic door operators, and may be applied to fire-rated applications when under the control of an **automatic fire alarm system**.

UL approved for Class II circuit applications.

The QEL option does not include the power transfer from door to frame, the power supply, or the control operator. Refer to EPT-2 power transfer and the PS902 or 914 power supply.

The PS902/914 with the 2RS, 4RL or 4R board is the minimum required. Other option boards available for other functions, see PS902/914 power supply for additional information.

QEL Electrical Load	
Voltage	24VDC
Current	1.4 A Inrush (0.5 sec.) 0.14 A Holding 2.0 A Calibrate (3 sec. one time)

To Order, Specify:

1. Standard — Use prefix QEL, example QEL33A-L.

Popular QEL Application

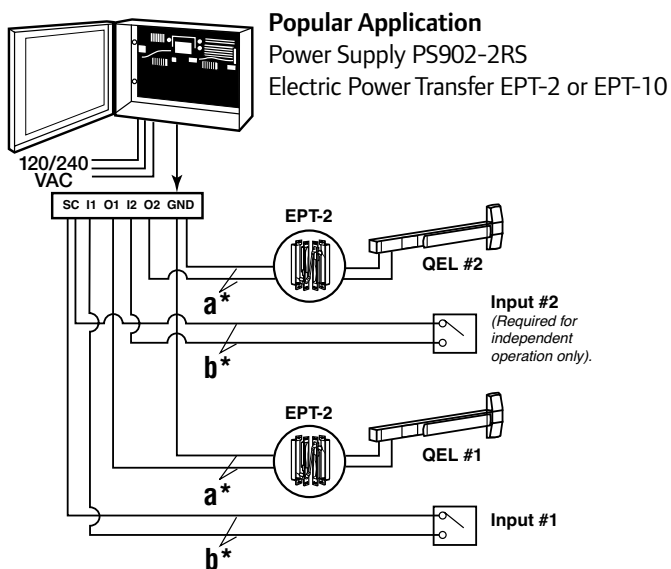

QEL Device Wire Selection Size

a*	Distance (one-way)	Wire Gauge
	200 ft.	18 AWG
	320 ft.	16 AWG
	500 ft.	14 AWG
	800 ft.	12 AWG

b*	Wire Selection	Switch Wire Size
	1200 ft. Max.	18 gauge standard

EL Electric Latch Retraction

The EL feature allows for the remote unlatching of exit devices. A control station operator can flip a switch to retract the latch bolt and immediately change an exit door to push-pull operation. A powerful, continuous duty solenoid retracts the latch bolt, either for momentary unlatching, or for extended periods of time. The EL feature is an alternative to manual dogging. If manual hex-key dogging is required, specify HD-EL.

EL devices are also useful with automatic door operators, and may be applied to fire-rated applications when under the control of an **automatic fire alarm system**. UL approved for Class II circuit applications.

The EL option does not include the power transfer from door to frame, the power supply, or the control operator. Refer to EPT-2 power transfer and the PS914 power supply.

The PS914 with the 900-2RS option card is minimum option card required. Other option cards available for other functions, see PS914 power supply for additional information.

Solenoid Specifications:

- Continuous Duty — 24 VDC
- Current Inrush — 16 Amps
- Current Holding — 0.3 Amps

To order, specify:

1. Standard — Use prefix EL, example EL33AL
2. Hex Key dogging — Use prefix HD-EL, example HD-EL33AL

Popular EL Application

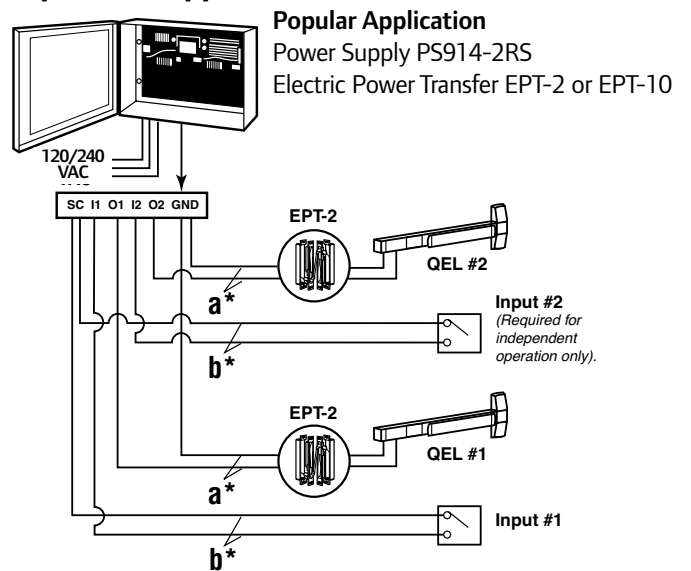

EL Device Wire Selection Size

	Von Duprin Exit Device	EL Wire Length (feet) ¹	Wire Gauge (AWG)
	EL 33A/35A Rim	0-500	12
		0-300	14
		0-200	16
a*	All other EL33A/35A device types	0-250	12
		0-150	14
		0-100	16
b*	Control Switch	0-1200	18

1. Wire lengths include an EPT, Door loop, electric hinge or pivot and are measured one way between the PS914/option board and the device.
2. Table is applicable to devices that have shipped after August 2012.

Power Supplies

Series PS902/914



Overview:

The PS900 Series is a consolidated line of power supplies and accessories that offer enhanced flexibility and functionality specific to the changing needs of the access control market. The PS900 Series can be used in a variety of applications to convert high voltage AC power into the low voltage DC outputs required by most access control devices. The PS900 Series protects devices downstream by providing Class 2*, filtered and regulated power. The full line is UL294 certified.

Note: PS906 can provide Class 2 rated outputs when used with 900-8P distribution board.

Features:

- Constant output rating at both 12 VDC and 24 VDC provides superior performance ; includes field selectable jumper
- Polarized connectors for option boards eliminate need for racks and side connectors
- Flat mounting of option boards provides easier access to terminal blocks for connection of electrified devices
- High voltage protective cover
- Battery back-up board auto-selects voltage
- Fire alarm relay can be configured to provide either switched or un-switched outputs from a power supply
- PS914 designed with high inrush current for powering electrified panic devices
- Universal 120-240 VAC input
- Low voltage DC, regulated and filtered
- Electronic power limiting foldback circuit for AC current overload protection
- Fused primary input
- AC status monitor- isolated SPDT contacts
- AC input and DC output LED status indicators
- Cover mounted AC input indication
- Hinged cover with lock down screws

Certifications:

- UL 294 certified—the standard for access control
- Class 2 rated*

* Except PS906, output rating exceeds Class 2 power limits

Once power is converted to low voltage DC, the PS900 Series offers a variety of distribution options, including basic fuse protection, simple relay, and advanced logic providing complex sequencing and timing functions.

* PS906 can provide Class 2 rated outputs when used with 900-8P distribution board.

	PS902	PS904	PS906	PS914
Number of Connectors on Power Supply for the following:	2 amps	4 amps	6 amps	4 amps
Distribution Boards	1	2	3	2
Battery Back-up Board	1	1	1	1

Note: One fire alarm board can be connected directly to the PS902. If a fire alarm board is desired for the PS904, PS906 or PS914 it can be connected to a distribution board.

Applications:

The PS900 Series of power supplies works with many electrified devices including Schlage electromagnetic locks, Schlage AD-Series hardwired locks, Schlage electrified mechanical locks, Von Duprin electrified strikes, Von Duprin exit devices, and many other brands.

Accessories:

The Schlage PS900 Series features seven option boards for use in a variety of applications. All Schlage PS900 Series power supplies option boards are UL 294 certified.

Option Boards:

900-4R: 4 relay controlled output board to power multiple devices

900-4RL: 4 relay distribution board with logic is field configurable for time delay function, auto operator, security interlock

900-8F: Provides 8 individually fuse-protected outputs, giving the flexibility to power multiple devices and provide another layer of protection

900-FA: Emergency interface relay integrates with fire alarm and is used to cut power in case of emergency

900-BB: Battery backup

900-2RS: 2 relay EL panic device control board (PS914 only)

900-BBK: Battery backup kit includes two 7A/hr batteries and provides up to four hours of backup power when cycled every 5 minutes at full load

EPT Electrical Power Transfer
PNT Pneumatic Transfer

Electric Power Transfer provides a means of transferring electrical power from a door frame to the edge of a swinging door. The units are completely concealed when the door is in the closed position, and are ideally suited for installations involving abuse or heavy traffic.



Two models are available; EPT-2, two 18 gauge wires and EPT-10, ten 24 gauge wires. The EPT-2 and EPT-10 are U/L listed as "miscellaneous door accessory".

Pneumatic Controls

PNT-1 is available for pneumatic latch retraction exit devices. Appearance and dimensions are identical to EPT models.

UL Listed for use on fire doors

Door applications:

- up to 5" butt hinges – 180° swing,
- 5½" butt hinges – 130° swing,
- 6" butt hinges – 110° swing,
- ¾" butt offset pivots 180° swing.

Not for use with swing clear hinges or center-hung pivots.

Finishes

- SP28 (sprayed aluminum)
- SP313 (sprayed duranodic).

Dimensions

Housing	9" x 1¼" x 1⅝" (229mm x 32mm x 38mm)
EPT-2	Two 18 gauge wires, Up to 2 AMPS @ 24VDC, with a 16 AMPS Maximum Surge
EPT-10	Ten 24 gauge wires, Up to 1 AMPS @ 24VDC, with a 16 AMPS Maximum Surge
PNT-1	⅝" Tubing

To order, specify:

1. EPT-2 ,EPT-10 or PNT-1.
2. Finish, SP28 or SP313.

33A/35A Mechanical Accessories

PN Pneumatic Controlled Exit Devices



The PN feature provides remote latch bolt retraction in hazardous areas where electrically operated devices would not be permitted. The pneumatic solenoid will retract the latch bolt for momentary or prolonged periods. PN exit devices are particularly suited for use with automatic door operators. The PN feature is available on both Panic and Fire Exit Hardware devices.

The PN feature includes a special actuating linkage that gives building owners the option of mechanically or pneumatically dogging the exit device. If manual hex-key dogging is required, specify HD-PN (Dogging the device, whether mechanically or pneumatically, makes the device function as a push/pull unit and reduces the wear on its moving parts.)

When activated pneumatically, the latch bolt(s) of the exit device retract in 1/2 to 1 1/2 seconds. This pneumatic operation uses air pressure ranging from 50 to 100 pounds per square inch.

This product will function only when it is part of a pneumatic system (air compressor, air lines, pneumatic system, etc.). Contact LCN for correct control boxes

To order, specify:

1. Standard — Use prefix PN, example PN33ANL
2. Hex Key Dogging — Use prefix HD-PN, example HD-PN33ANL

Dogging Options

LD Less Dogging

Less Dogging is available in all 33A/35A Panic Exit devices to remove the dogging option.

To order, specify: 1. Use prefix LD, example LD33AL

CD Cylinder Dogging

Cylinder dogging is available on all 33A/35A Panic Exit devices to replace the standard hex key dogging. Unit requires a standard 1 1/4" (32mm) mortise cylinder with a straight cam (Schlage Cam B502-191 reference).

To order, specify: 1. Use prefix, CD, example CD33AL

CDK Cylinder Dogging Kit

For field conversion, a cylinder dogging conversion kit is available. Cannot be added to fire exit hardware.

Order: 33A/99CDK or 35A/98CDK, specify finish

SS Signal Switch



Monitors pushpad and latch bolt

The SS feature is used to signal the unauthorized use of an opening. This device is equipped with two internal SPDT switches. One switch monitors both the pushpad and the latch bolt assembly, making the latch bolt tamper resistant, for positive security. An additional SPDT switch is connected to the 1 1/4" (32mm) mortise with straight cam for alarm "bypass." (Schlage cam reference B502-191). The device can be connected to a security console, or may be used as a single door alarm when used with a horn and power supply. A continuous current electric transfer must be used for transferring power from the frame to the door.

To order, specify:

1. Prefix SS, example SS33AL
2. Handing Required, LHR or RHR

Electrical Ratings:

Up to 2.0 AMPS @ 24VDC

Popular SS Application

Unauthorized use of this opening will activate the local horn.

The key switch permits inhibiting this system for authorized entry.

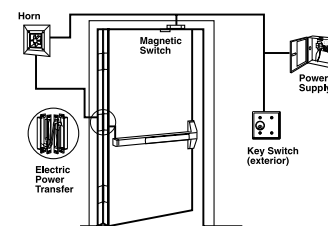

SG Safety Glow

Self-illuminating touchpad defines the location of the exit door in dark or smoke-filled area. The Safety Glow coating is a special powder coat finish that glows brightly during low or no light conditions. This coating was developed to meet MEA standards where luminescent exit door markings are required in commercial facilities. There are no batteries or electronics, the coating is charged when exposed to light.

To order, specify: Suffix SG, EL 9927L-SG

Dummy Pushpad



The 330 dummy pushpad is designed as a companion unit for all 33A devices. The 350 dummy pushpad is a companion unit for all 35A devices. The pushpad is rigid or nonfunctioning. A push/pull operation can be accomplished by using 386DT, 360L-DT, 550DT, 392-6 trim or any Ives Pull.

The 330/350 can be equipped with a functional pushpad and will accommodate an RX switch. Specify RX-330. May also be equipped with the RX2, double RX switch. Specify RX2-330

To order, specify:

1. 330 or 350
2. Size 3' or 4' (914mm or 1219mm)
3. Finish, US3, US4, US10, US26, US26D, US28, 313AN, 315AN, 350 Only US32D.

RG-27 Vertical Rod and Latch Guard



Series RG-27 Vertical Rod and Latch Guards protect the bottom rods of exit devices from the damaging impacts of carts or gurneys passing through doors. (If bottom rods become damaged, the exit device will not function as intended and can jeopardize the ability to exit safely during an emergency.)

In addition to protecting the vertical rod, the guard provides a smooth, unobstructed surface so the door can be pushed open easily with the bumpers of a wheelchair. The latch guard portion is 10" high. The standard latch guard features a 45° ramp. The extended latch guard offers a continuous ramp in 3' or 4' widths.

All stainless steel construction in US32D finish. Latch guards can cover latches as large as 1¼"W x 10"H x 1⅞" projection.

Rod Guard

Latch Guard

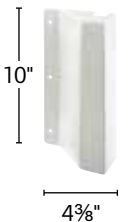

Extended Latch Guard



Models

- RGO** Rod guard only (Projection 1⅞")
- RG-27** Rod and latch guard
- RG-27-3** 3' (914mm) Rod Guard and Extended Latch Guard
- RG-27-4** 4' (1219mm) Rod Guard and Extended Latch Guard
- LGO** Latch guard only
- LGO-3** 3' (914mm) Extended latch guard only
- LGO-4** 4' (1219mm) Extended latch guard only

Note: Wood Doors - Can be used on fire doors with High Density Blocking with sheet metal screws. For non-fire rated wood doors use sex bolt.

To order, specify:

1. Model number.
2. Handing (except on RGO).
3. Door material if other than Hollow Metal.
4. Optional sex bolt mounting available.

LBR/LBL Less Bottom Rod/Less Bottom Latch

LBR/LBL option is available, using a spring loaded auxiliary latch bolt installed in the lower door edge. When exposed to heat the auxiliary latch bolt releases, keeping the doors in alignment and closed during a fire. UL listed 3 hours on hollow metal doors double egress, 90 minute swinging same direction, and 20 minutes wood doors (consult wood door manufacturer). Fits door stiles as narrow as 3⅝".

LBR/LBL devices must be ordered in pairs or must be used in conjunction with an approved automatic or constant latching flush bolt.

LBR/LBL used on non-fire rated devices, the spring loaded auxiliary latch bolt is not required. Device is supplied less bottom rod, latch and strike.

PL Pullman Latch

When PL is specified the standard latches are replaced with pullman style latches. Pullman latches are always extended and are most commonly used in conjunction with electric strikes and LBR-less bottom rod application. Not available with Fire rated devices. Not recommended where security is of the utmost since latches do not deadlock.

GBK Glass Bead Kit

Glass bead conversion kits are available for all 33A/35A Series devices for use on doors with raised glass beads. Each kit consists of ¼" (6mm) shim sets. GBK for Surface Vertical Rod ships with ⅛" shims for rod guides.

To order, specify:

1. 33AGBK
2. Device type (Rim, Mortise, Surface Vertical Rod, Concealed Vertical Rod)
3. Wood Door, when used with Concealed Vertical Rod

WDA Cover Plate Kit

For wood door applications, used to cover up door preparations for control, also prevents the control from boring into the wood door. Finished to match control.



**UL Listed —
Fire Exit Hardware Label/Opening Size**

Double Door		
Exit Device	Same Direction	Double Egress
3327A-F	90 Min. 8' x 10'	3 Hour 8' x 10'
3527A-F	90 Min. 8' x 10'	3 Hour 8' x 10'
3347A-F	90 Min. 8' x 10'	3 Hour 8' x 10'
3547A-F	90 Min. 8' x 10'	3 Hour 8' x 10'
3347A-F*	90 Min. 8' x 9'3"	90 Min. 8' x 9'3"
3547A-F*	90 Min. 8' x 9'3"	90 Min. 8' x 9'3"
3348A-F	90 Min. 8' x 10'	3 Hour 8' x 10'
3548A-F	90 Min. 8' x 10'	3 Hour 8' x 10'
3349A-F	90 Min. 8' x 10'	3 Hour 8' x 10'
3549A-F	90 Min. 8' x 10'	3 Hour 8' x 10'

* 3347A-F and 3547A-F used on wood door.

Cylinders

Cylinders are not furnished with device or trim and must be specified when ordering. Refer to trim pages for cylinder type.



Mortise — 3215 (Schlage 20-001, B502-191 cam)



Rim — 3216 (Schlage 20-022 cam)

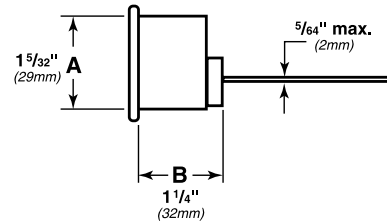
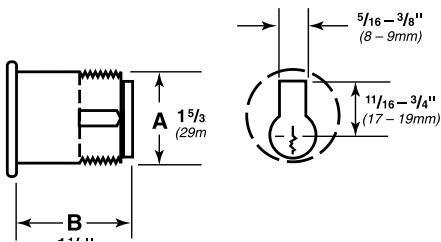

Dogged (Inverted) Cam

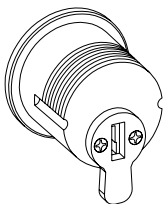

For Cylinder Dogging
or 360L



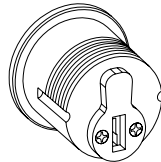

Undogged Cam (Standard Operations)

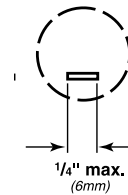

For Standard Trim Functions
or 360L-NL





Finishes*

	Color	US Number	BHMA Number
	Chromium, Polished	US26	625
	Anodized, Aluminum	US28	628
	Chromium, Dull	US26D	626
	Brass, Polished	US3	605
	Brass, Dull	US4	606

	Color	US Number	BHMA Number
	Bronze, Dull	US10	612
	Satin Nickel <i>Available for 35A ONLY</i>	US15	619
	Duranodic Dark Bronze	313	710
	Black	315	711

Special Finishes

	Color	US Number	BHMA Number
	Satin Chrome, Antimicrobial	US26D-AM	626-AM
	Aged Bronze 643e	—	—

Pushpad Options — Knurled
 Embossed “Push”
 Braille (Caution-Stairwell), satin stainless steel only
 RSS – (Emergency Exit – Push to open and sound alarm) – Red Silkscreen lettering on US32D

* **NOTE:** Durable powder coated finishes available at specific special request. PLEASE CONTACT FACTORY.



Ingersoll Rand (NYSE:IR) advances the quality of life by creating and sustaining safe, comfortable and efficient environments. Our people and our family of brands—including Club Car®, Ingersoll Rand®, Schlage®, Thermo King® and Trane®—work together to enhance the quality and comfort of air in homes and buildings; transport and protect food and perishables; secure homes and commercial properties; and increase industrial productivity and efficiency. Ingersoll Rand Security Technologies' market-leading products include electronic and biometric access control systems; time-and-attendance and personnel scheduling systems; mechanical locks; portable security; door closers, exit devices, architectural hardware, and steel doors and frames; and other technologies and services for global security markets. Ingersoll Rand is a \$14 billion global business committed to a world of sustainable progress and enduring results.

securitytechnologies.ingersollrand.com

ingersollrand.com