



L-Series

Commercial Locks



Contents

- 4 L-Series Commercial Locks
- 6 Schlage L9000 Series
- 7 Schlage L400 Series
- 8 M Collection Decorative Lever Designs and Finishes
- 10 Standard Lever Designs and Finishes
- 12 Danmark Lever Designs and Finishes
- 14 Escutcheons and Roses
- 15 Thumbturns
- 16 Lock Components
- 17 Lock Functions - ANSI A156.13, Series 1000
- 18 Lock Functions - Single Cylinder Non-Deadbolt
- 19 Lock Functions - Single Cylinder Deadbolt
- 20 Lock Functions - Double Cylinder Non-Deadbolt and Deadbolt
- 21 Lock Functions - Full Mortise and Small Mortise Deadlocks
- 22 L-Series Universal Transformation Instructions
- 24 Electrified Lock Function
- 25 Cylinder Types
- 26 Standard (Non-IC) Cylinders
- 27 Full-Size Interchangeable Core (FSIC) Cylinders
- 28 Small Format Interchangeable Core (SFIC) Cylinders
- 29 Blocking and Compression Rings
- 30 Classroom Thumbturn Cylinders
- 31 Armored Fronts
- 32 Strikes
- 33 Door Handing
- 34 Specifications
- 34 Certifications
- 35 How to Order





Put Your Trust in the Name You Know

For more than 85 years Schlage® has been providing innovative security solutions for schools, hospitals, hotels, condominiums and a host of other commercial buildings. Today, Schlage is at the forefront of cutting-edge technology such as wireless security products, biometrics and CCTV. With a wide range of products, styles and finishes, Schlage has what you need no matter how demanding your project specifications may be. And we stand behind every lock we make with some of the best after-sales service in the business. It's this commitment to design, performance and technology that ensures you can stand behind our products too.



Real Security is Knowing Exactly What You Want and Getting It

When you know exactly what you want, you don't want to waste time finding out whether it meets your project specifications. That's why we offer the world's largest team of hardware specification writers to help you and your clients turn your vision into reality. And when it comes to products, our commercial suiting options, wide variety of lever designs and rich selection of finishes give you the tools you need to make your projects perfect. You know what you want. With Schlage you can be sure you'll get it.

Safety, Security and Confidence

When you choose a Schlage lock you can be sure you've done the job right the first time. After all, our products are among the most durable and dependable on the market today. Our locks are easy to install, and simple to repair and maintain. That means fewer callbacks for you and total safety and security for your customers.



L-Series

Commercial Locks

Nothing is tougher.

At Schlage we know that every product you specify has to stand up to constant use and abuse. Your building's locking systems face an additional challenge – keeping people and other assets safe while delivering constant, reliable performance. Schlage L-Series Extra Heavy Duty Mortise Locks are built to withstand the rigors of daily use without fail.

We don't compromise on security.

The safety and security of your clients' buildings is something we take very seriously. That's why every Schlage lock and deadbolt undergoes intensive testing to determine its ANSI grade level:

- Cycle tests
- Door impact tests
- Bolt strength tests
- Resistance tests
- Warped door tests

We pay attention to these details so you can focus on creating a functional and aesthetically pleasing environment for your clients. In fact, every one of our L-Series locks meets ANSI Grade 1 standards for safety.

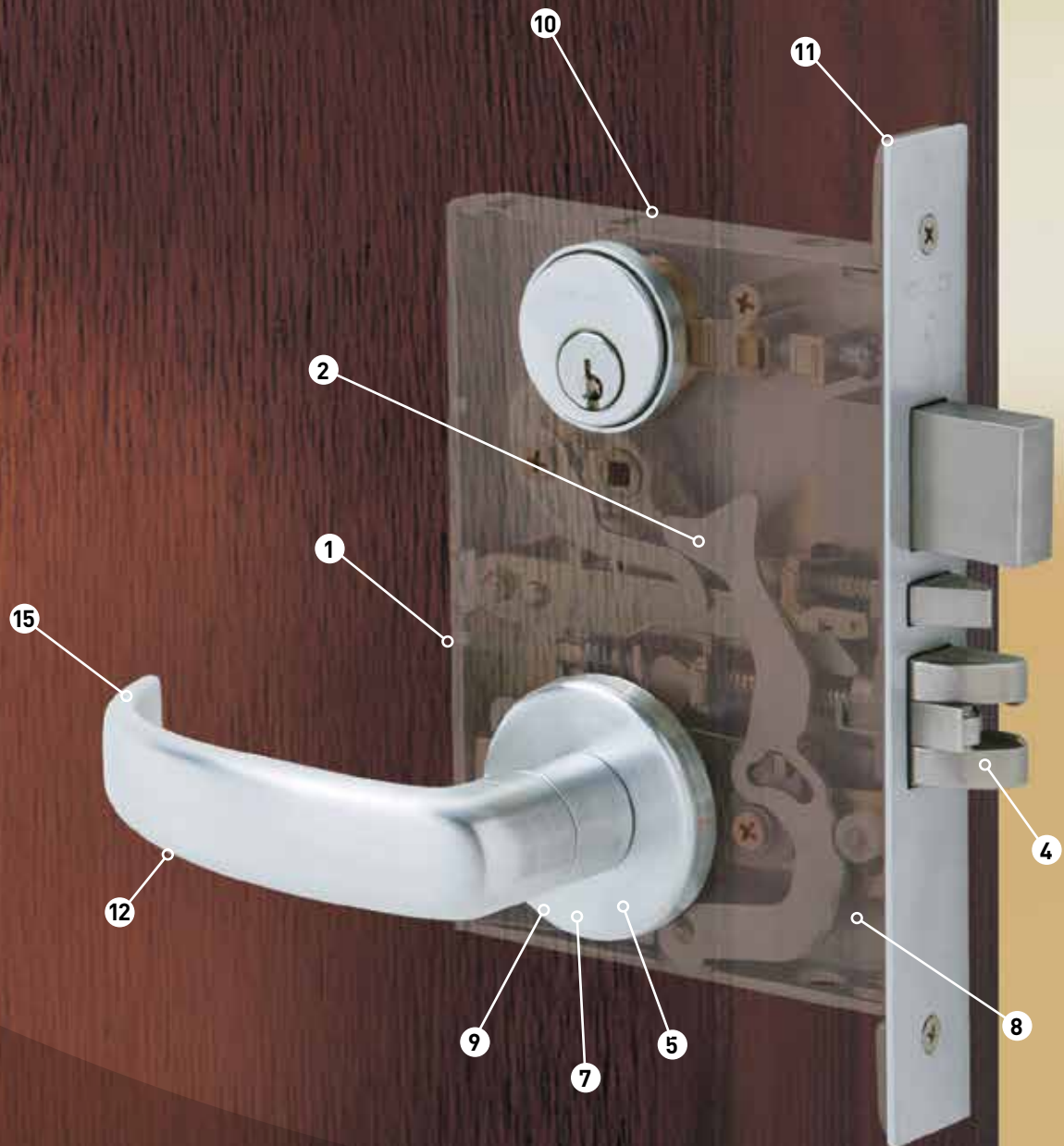

Vandlgard®

The L-Series Vandlgard is ideal for areas subject to abuse or anywhere vandalism is likely to be present. Vandlgard prevents damage to internal lock components caused by excessive force from kicking, hitting or standing on the lever to gain access.

It's easy to retrofit standard L-Series locks with Vandlgard using the Vandlgard Retrofit Kit and an instructional DVD that shows installation on existing hardware.

The Right Lock for Every Application

Schlage L9000 Series

Our L9000 Series locks are ideal for use in schools, hospitals and factories, where the finest hardware must also deliver consistent, dependable operation and stand up to constant use and abuse.

Strength and Durability

1. Fully wrapped heavy-gauge steel case protects against door edge attacks
2. All-metal zinc dichromate-plated working parts
3. Inside lock case protects electronic components
4. Two-piece anti-friction tongue reduces wear and tear
5. Outside and inside trim thru-bolted together and through the door

Security Built In

6. Break-away spindle prevents unsecured failures and provides easy spindle replacement
7. Hub blocking plate protects lock against spindle manipulation
8. Spring-loaded fusible link provides fail secure mode in case of fire
9. Inside lever applied by screwless shank mounting – no exposed trim mount screws

Adaptable To Your Application

10. Universal lock case – ten functions in one case
11. Floating mounting tabs automatically adjust to fit a beveled door edge
12. Field-reversible handing without opening lock case
13. External spring cages allow for simple trim retrofit
14. Locking thumbturn on the inside of door visually shows when the door is locked and unlocked
15. Lever rotation in both directions (up and down) for ease of use
16. Independent lever rotation

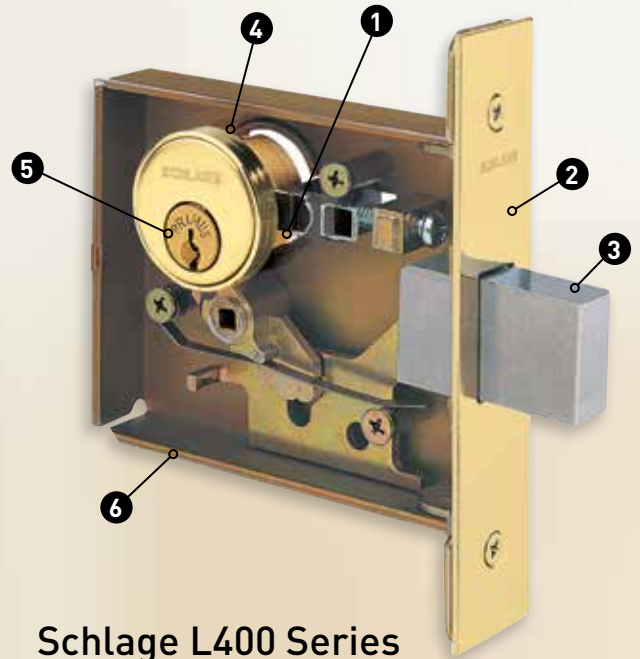

Schlage L400 Series

Our L400 Series locks are designed for use as primary locks where no latching is required, such as restrooms and small doors to utility spaces. They also offer optimum security when used as auxiliary locks in other applications.

1. High-strength steel alloy cylinder retainer
2. Armored front in brass, bronze or stainless steel; adjustable for door bevel
3. 1" (25 mm) stainless steel throw deadbolt
4. Deeper retainer groove in cylinder shell increases security against wrenching and pullout; all cylinders backward compatible
5. 6-pin Everest® cylinder with patented keys standard
6. Steel case and parts are corrosion resistant

M Collection Decorative Lever Designs

A range of options. A single standard of quality.

Introducing the M Collection, an entire lineup of decorative levers designed to maintain a custom high-style look on doors throughout any building— from the main entrance to the supply closet.



M51
Material: Forged brass and cast stainless steel



M52
Material: Forged brass and cast stainless steel



M53
Material: Forged brass and cast stainless steel

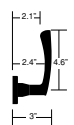

M56
Material: Forged brass and cast stainless steel



M57
Material: Cast stainless steel



M61
Material: Forged brass and cast stainless steel

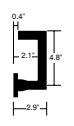

M81
Material: Forged brass and cast stainless steel



M82
Material: Forged brass and cast stainless steel



M83
Material: Forged brass and cast stainless steel











All 15 of the M Collection levers can be paired with any of these commercial graded products for suiting across an office, a floor or an entire building.

- Schlage L-Series Mortise
- Schlage LT-Series Tubular - available April 2014
- Von Duprin 98/99 Exit Devices
- Von Duprin 33A/35A Exit Devices
- Von Duprin 94/95 Exit Devices

The ability to suite M Collection levers across multiple platforms from Schlage and Von Duprin means consistent style and functionality—along with unrivaled security. The M Collection was designed to function as a visual extension of any interior, from contemporary to classic. Its streamlined design is void of unsightly screws, allowing the lever to accent your door without distraction.

Finish Key*

-  605 Bright Brass
-  606 Satin Brass
-  609 Antique Brass
-  619 Satin Nickel
-  625 Bright Chromium Plated
-  626 Satin Chromium Plated
-  629 Bright Stainless Steel
-  630 Satin Stainless Steel
-  643e Aged Bronze



M54
Material: Forged brass and cast stainless steel



M55
Material: Forged brass and cast stainless steel



M62
Material: Cast stainless steel



M63
Material: Forged brass and cast stainless steel



M84
Material: Forged brass and cast stainless steel

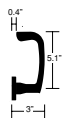

M85
Material: Forged brass and cast stainless steel



Standard Lever Designs

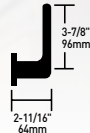

01

Material: Forged brass, bronze and cast stainless steel



02

Material: Forged brass, bronze and cast stainless steel

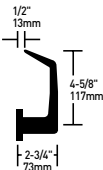

06

Material: Forged brass, bronze and cast stainless steel

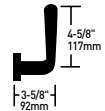

07

Material: Forged brass, bronze and cast stainless steel

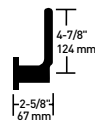

18

Material: Forged brass, bronze and cast stainless steel

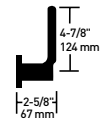

Accent (ACC)
Material: Forged brass

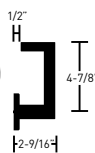

Longitude

Material: Forged brass and cast stainless steel

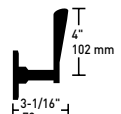

Merano

Material: Forged brass



All 16 of the Standard levers can be paired with any of these commercial graded products for suiting across an office, a floor or an entire building.

- Schlage L-Series Mortise
- Schlage LT-Series Tubular - available April 2014
- Von Duprin 98/99 Exit Devices
- Von Duprin 33A/35A Exit Devices
- Von Duprin 94/95 Exit Devices



03

Material: Forged brass, bronze and cast stainless steel

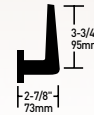

05

Material: Forged brass, bronze and cast stainless steel

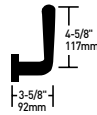

12

Material: Forged brass, bronze and cast stainless steel

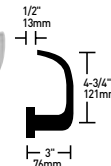

17

Material: Forged brass, bronze and cast stainless steel

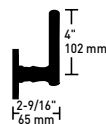

ASTI (AST)

Material: Forged brass

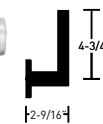

Latitude

Material: Forged brass and cast stainless steel



Omega (OME)

Material: Forged brass, bronze and cast stainless steel

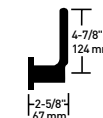

St. Annes (STA)

Material: Forged brass



Finish Key*



605
Bright Brass



606
Satin Brass



609
Antique Brass



612
Satin Bronze



613
Oil Rubbed Bronze



619
Satin Nickel



625
Bright Chromium Plated



626
Satin Chromium Plated



629
Bright Stainless Steel



630
Satin Stainless Steel



643e
Aged Bronze

danmark Lever Designs



615
Material: Cast stainless steel



621
Material: Cast stainless steel



695
Material: Cast stainless steel

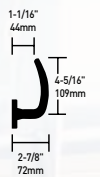

615
Material: Cast stainless steel

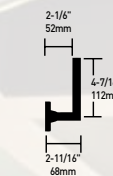

690
Material: Cast stainless steel



Finish Key



630
Stainless Steel



660
Material: Cast stainless steel

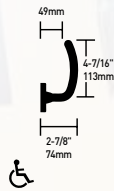

650
Material: Cast stainless steel

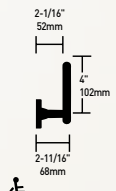

696
Material: Cast stainless steel

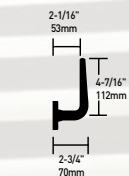

640
Material: Cast stainless steel

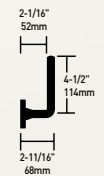

Escutcheons and Roses

Choose from three types of escutcheon and two rose sizes to add tough, durable performance to your lockset.

Escutcheons



L Full Face

Material: Cold-forged brass, bronze or stainless steel

Finishes: 605, 606, 609, 612, 613, 619, 625, 626, 629, 630, 643e

Size: 8" x 1 3/4" x 7/16"
(203 mm x 44 mm x 11mm)



L Concealed

Material: Cold-forged brass, bronze or stainless steel

Finishes: 605, 606, 609, 612, 613, 619, 625, 626, 629, 630, 643e

Size: 8" x 1 3/4" x 7/16" (203 mm x 44 mm x 11 mm)



N Escutcheon

Material: Heavy wrought reinforced brass, bronze or stainless steel

Finishes: 605, 606, 609, 612, 613, 619, 625, 626, 629, 630, 643e

Size: 8" x 2 9/16" x 7/16"
(203 mm x 65 mm x 11 mm)



Roses



A Wrought Rose

2 1/8" (54 mm) diameter

Available for use on L-Series knob and lever designs.

Order by letter designation corresponding to the design and diameter desired.

Finishes: 605, 606, 609, 612, 613, 619, 625, 626, 629, 630, 643e



B Wrought Rose

2 9/16" (65 mm) diameter

Available for use on L-Series knob and lever designs.

Order by letter designation corresponding to the design and diameter desired.

Finishes: 605, 606, 609, 612, 613, 619, 625, 626, 629, 630, 643e

Thumbturns

Choose from three variations of thumbturn locks that help you meet the demands of specialized commercial projects.



Hotel Occupancy Indicator
09-611
For lock function L9486P, this unit can be used with A or B roses. Requires a 13/8" (35 mm) cylinder for 13/4" (44 mm) doors. Specify finish when ordering separately.



Optional EZ Turn
L583-363
Available for rose and escutcheon trim. Disability turn (ADA) option to standard thumbturn. Can be used with thumbturn-function L-Series lock except L9463 and L463. Specify lock per L583-363 when ordering.



Coin Turn
For lock functions L9044 and L9444 with rose trim. Specify 09-509 and finish per L283-124 when ordering.

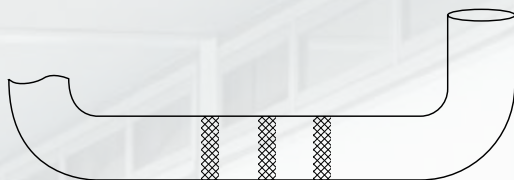

03 Lever Shown

Tactile Warning (Knurling)

Schlage L-Series commercial levers feature knurling only on the outside lever unless otherwise specified. This feature is available on the following lever models: 01, 02, 03, 05, 06, 07, 12, 17, 18, 41, 42 and 93.

Products featuring a knurled surface will be indicated by adding the prefix "8" to the lever number. For example, L9050P 803A/03A.

Lock Functions

Lock Components

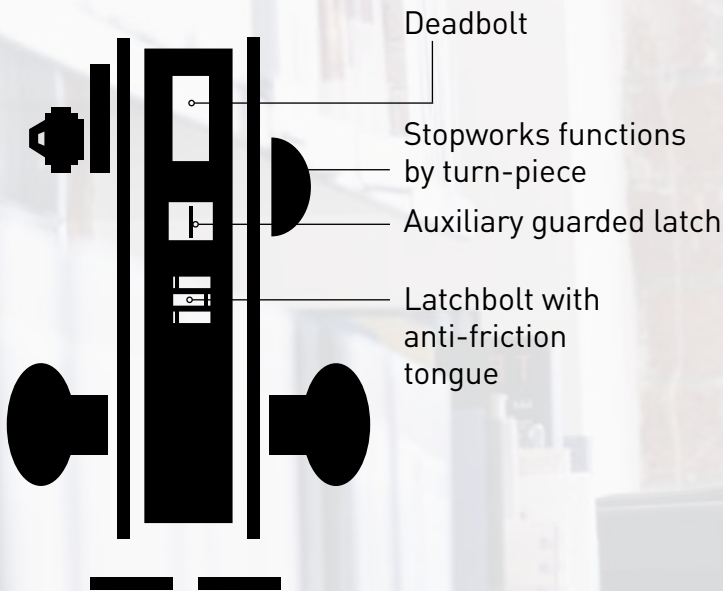

Symbol Key

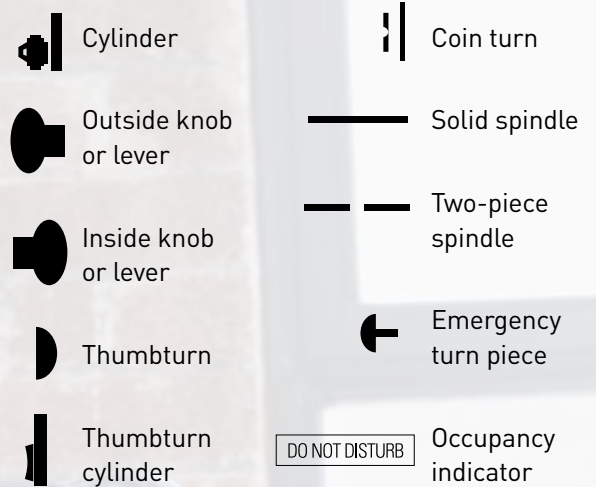

Product Identification Guide

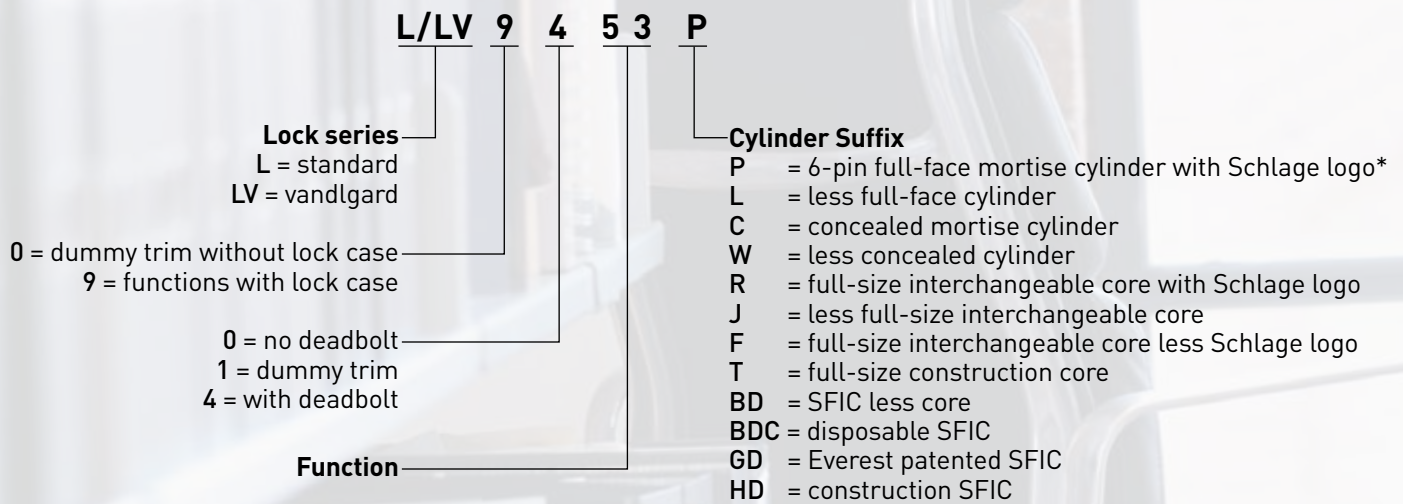

SFIC = Small Format (Best® style) Interchangeable Core

To order less Schlage logo, specify lock "with K510-612 faceplate."

LV = Vandlgard® function allows exterior lever to rotate freely down while remaining securely locked.

Lock Functions | ANSI A156.13, Series 1000

Schlage ANSI



L9010 **F01**
Passage Latch

Latchbolt retracted by knob/lever from either side at all times. Inside lever is always free for immediate egress.



L9040 **F22**
LV9040
Bath/Bedroom Privacy Lock

Latchbolt retracted by knob/lever from either side unless outside is locked by inside thumbturn. Turning inside knob/lever or closing door unlocks outside knob/lever. To unlock from outside remove emergency button, insert emergency thumbturn (furnished) in access hole and rotate. Inside lever is always free for immediate egress.



L9044
LV9044
Privacy With Coin Turn Outside

Latchbolt retracted by knob/lever from either side unless outside is locked by inside thumbturn or outside coin turn. Operating inside knob/lever, closing door, rotating inside thumbturn or rotating outside coin turn unlocks outside knob/lever. Specify per L283-056 for Torx® screws. Available with rose trim only. (Previously XL11-868)



L9440
LV9440 **F19**
Privacy With Deadbolt

Latchbolt retracted by knob/lever from either side. Deadbolt thrown or retracted by inside thumbturn. Throwing deadbolt locks outside knob/lever. Rotating inside knob/lever simultaneously retracts deadbolt and latchbolt, and unlocks outside knob/lever. To unlock from outside remove emergency button, insert emergency thumbturn in access hole and rotate. Inside liner is always free for immediate egress. (Previously XL11-761.)

Schlage ANSI



L9444
LV9444
Privacy with Deadbolt and Coin Turn Outside

Latchbolt retracted by knob/lever from either side. Deadbolt thrown or retracted by inside thumbturn or outside coin turn. Throwing deadbolt locks outside knob/lever. Rotating inside knob/lever simultaneously retracts deadbolt and latchbolt, and unlocks outside knob/lever. Rotating outside coin turn retracts deadbolt and unlocks outside knob/lever. Specify per L283-056 for Torx screws. Available with rose trim only. Inside lever is always free for immediate egress. (Previously XL11-868)

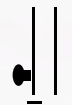

L0170
Half Dummy Trim

Knob/lever on one side fixed by mounting bar.

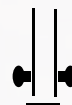

L0172
Full Dummy Trim

Knob/lever on both sides fixed by mounting bar.



L9175
Half Dummy Trim with Lock Case

Fixed knob/lever on one side inoperable. Includes lock case and armored front. Options same as L9176 below.



L9176
Full Dummy Trim with Lock Case*

Fixed knob/lever on both sides. Includes lock case and blank armor front. May be ordered with optional XL11-743 armored front with cutout to receive deadbolt.

*In a double-door application where the dummy will be used as the strike order 10-091 Armored Front Strike separately.

Lock Functions | Single Cylinder Non-Deadbolt Functions

Schlage ANSI



L9050
LV9050

Office and Inner Entry Lock

Latchbolt retracted by knob/lever from either side unless outside is made inoperative by key outside or by turning inside thumbturn. When outside is locked, latchbolt is retracted by key outside or by knob/lever inside. Outside knob/lever remains locked until thumbturn is returned to vertical or unlocked by key. Auxiliary latch deadlocks latchbolt when door is closed. Inside liner is always free for immediate egress.



L9056
LV9056

L9050 with Automatic Unlocking

Latchbolt retracted by knob/lever from either side unless outside is made inoperative by key outside or by rotating inside thumbturn. Outside knob/lever unlocked by key outside, thumbturn or closing door. Rotating inside knob/lever simultaneously retracts latchbolt and unlocks outside knob/lever. Auxiliary latch deadlocks latchbolt when door is closed. Inside lever is always free for immediate egress.



L9070
LV9070

Classroom Lock

Latchbolt retracted by knob/lever from either side unless outside is locked by key. Unlocked from outside by key. Inside knob/lever always free for immediate exit. Auxiliary latch deadlocks latchbolt when door is closed. Inside lever is always free for immediate egress.



L9076
LV9076

Classroom Holdback Lock

Latchbolt retracted by knob/lever from either side unless outside is locked by key. When locked, latchbolt retracted by key outside or knob/lever inside. Auxiliary latch deadlocks latchbolt when door is closed. Depress inside knob/lever and turn key 360° for holdback feature. Inside lever is always free for immediate egress.



L9080
LV9080

Storeroom Lock

Latchbolt retracted by key outside or by knob/lever inside. Outside knob/lever is always inoperative. Auxiliary latch deadlocks latchbolt when door is closed. Inside lever is always free for immediate egress.



L9080EL
LV9080EL

Electrically Locked (Fail Safe)

Outside knob/lever continuously locked by 24V AC or DC. Latchbolt retracted by key outside or by knob/lever inside. Switch or power failure allows outside knob/lever to retract latchbolt. Auxiliary latch deadlocks latchbolt when door is closed. Inside knob/lever always free for immediate exit. Inside lever is always free for immediate egress.

Schlage ANSI



L9080EU
LV9080EU

Electrically Unlocked (Fail Secure)

Outside knob/lever unlocked by 24V AC or DC. Latchbolt retracted by key outside or knob/lever inside. Auxiliary latch deadlocks latchbolt when door is closed. Inside lever is always free for immediate egress.



L9080EL-RX / LV9080EL-RX
L9080EU-RX / LV9080EU-RX

Request to Exit (RX) Electrified Lock

Same as L9080EL and L9080EU functions. In addition, a micro-switch positioned inside the lock case monitors the retractor crank, and is actuated when rotation of the inside or outside knob/levers rotates the retractor hub. The switch signals the use of that opening to security systems, allowing a non-disruptive means of immediate egress. Specify per L283-263 with L functions, specify L283-239 with LV functions. Inside lever is always free for immediate egress.

Lock Functions | Single Cylinder Deadbolt Functions

Schlage ANSI



L9453 **F20**
LV9453
Entrance Lock

Latchbolt retracted by knob/lever from either side unless outside is locked by 20° rotation of thumbturn. Deadbolt thrown or retracted by 90° rotation of thumbturn. When locked, key outside or knob/lever inside retracts deadbolt and latchbolt simultaneously. Outside knob/lever remains locked until thumbturn is restored to vertical position. Throwing deadbolt automatically locks outside knob/lever. Auxiliary latch deadlocks latchbolt when door is closed. Inside lever is always free for immediate egress.



L9456 **F13**
LV9456
Corridor Lock

Latchbolt retracted by knob/lever from either side. Deadbolt thrown or retracted by key outside or inside thumbturn. Throwing deadbolt locks outside knob/lever. Turning inside knob/lever simultaneously retracts deadbolt and latchbolt and unlocks outside knob/lever. Inside lever is always free for immediate egress.



L9465
Closet/Storeroom Lock

Latchbolt retracted by knob/lever from either side. Deadbolt thrown or retracted by key outside.



L9473 **F21**
Dormitory/Bedroom Lock

Latchbolt retracted by knob/lever from either side. Deadbolt thrown or retracted by key outside or thumbturn inside.



L9480
LV9480
Storeroom Lock With Deadbolt

Latchbolt retracted by key outside or by lever or knob inside. Outside knob/lever always fixed. Deadbolt thrown or retracted by key outside or thumbturn inside. Turning inside knob/lever simultaneously retracts both deadbolt and latchbolt. Auxiliary latch deadlocks latchbolt when door is closed. Inside lever is always free for immediate egress. (Previously XL11-591)



L9485 x XL11-557
Prison Function Lock

Latch retracted by key outside or knob inside. Outside knob always free spinning. Deadbolt only thrown or retracted by guard's key. Inside knob becomes fixed when deadbolt is thrown. Prisoner's key only retracts latchbolt. Furnished standard with tamper-resistant Torx screws. Specify per XL11-557.

Schlage ANSI



L9485
LV9485
Faculty / Hotel / Restroom Lock

Latchbolt retracted by key outside or by knob/lever inside. Outside knob/lever always fixed. Deadbolt thrown or retracted by inside thumbturn. When deadbolt is thrown all keys become inoperative except emergency or display keys. Turning inside knob/lever retracts both deadbolt and latchbolt simultaneously. Auxiliary latch deadlocks latchbolt when door is closed. Inside lever is always free for immediate egress.



L9486 **F15**
LV9486
Faculty / Hotel / Restroom Lock
"Do Not Disturb" Indicator

Latchbolt retracted by key outside or by knob/lever inside. Outside knob/lever always fixed. Deadbolt thrown or retracted by inside thumbturn. When deadbolt is thrown "Do Not Disturb" plate is displayed. All keys become inoperative except emergency or display keys. Turning inside knob/lever retracts both deadbolt and latchbolt simultaneously. Auxiliary latch deadlocks latchbolt when door is closed. Inside lever is always free for immediate egress.



L9486 x L583-375
LV9486 x L583-375
L9486 with "Occupied" Indicator

Latchbolt retracted by key outside or by knob/lever inside. Outside knob/lever always fixed. Deadbolt thrown or retracted by inside thumbturn. When deadbolt is thrown "Occupied" plate is displayed and all keys become inoperative except emergency keys. Turning inside knob/lever simultaneously retracts both deadbolt and latchbolt. Auxiliary latch deadlocks latchbolt when door is closed. Inside lever is always free for immediate egress. (Previously XL11-580)



L9496
Privacy with "Occupied" Indicator

Knob/lever retracts latchbolt from either side. Deadbolt thrown or retracted by key outside (retraction by key required in the event of an emergency) or inside thumbturn. Throwing deadbolt locks outside knob/lever and displays "Occupied" plate. Rotating inside knob/lever simultaneously retracts both deadbolt and latchbolt, and unlocks outside knob/lever. Inside lever is always free for immediate egress. (Previously XL11-885)

*In a double-door application where the dummy will be used as the strike order 10-091 Armored Front Strike separately.

Lock Functions | Double Cylinder Non-Deadbolt Functions

Schlage ANSI



L9060
LV9060
Apartment Entrance Lock

Latchbolt retracted by knob/lever from either side unless outside is locked by key from inside. When locked, latchbolt retracted by key outside or knob/lever inside. Auxiliary latch deadlocks latchbolt when door is closed. Inside lever is always free for immediate egress.



L9071
LV9071
Classroom Security Lock

Latchbolt retracted by knob/lever from either side unless outside is locked by key from either side. When locked, latchbolt retracted by key outside or knob/lever inside. Auxiliary latch deadlocks latchbolt when door is locked. Inside lever is always free for immediate egress.



L9077
LV9077
Classroom Security Holdback Lock

Latchbolt retracted by knob/lever from either side unless outside is locked by key from either side. When locked, latchbolt retracted by key outside or knob/lever inside. Auxiliary latch deadlocks latchbolt when door is locked. Depress inside knob/lever and turn key 360° for holdback feature. Inside lever is always free for immediate egress.



L9082 **F30**
LV9082
Institution Lock

Latchbolt retracted by key from either side. Knob/lever on both sides always inoperative. Auxiliary latch deadlocks latchbolt when door is closed.



L9082EL
L9082EU
L9082 Electrically Locked or Electrically Unlocked Both Sides*

EL: Outside and inside knob or lever continually locked electrically. Latchbolt retracted by key either side. Switch or power failure allows outside and inside knob/lever to retract latchbolt. Auxiliary latch deadlocks latchbolt when door is closed. EU: Outside and inside knob/lever unlocked electrically. Latchbolt retracted by key either side. Switch or power failure keeps inside and outside knob/lever locked. Auxiliary latch deadlocks latchbolt when door is closed. (Previously XL11-452)

Lock Functions | Double Cylinder Deadbolt Functions

Schlage ANSI



L9457
LV9457
Classroom Security Lock with Deadbolt

Latchbolt retracted by knob/lever from either side. Deadbolt thrown or retracted by key from either side. Throwing deadbolt locks outside knob/lever. Turning inside knob/lever simultaneously retracts deadbolt and latchbolt, and unlocks outside knob/lever. Inside lever is always free for immediate egress.



L9466 **F14**
Store/Utility Room Lock with Deadbolt*

Latchbolt retracted by knob/lever from either side. Deadbolt thrown or retracted by key from either side.











L9482 x XL11-943
LV9482 x XL11-943
Institution Lock with Deadbolt*

Latchbolt retracted by key from either side. Knob/lever on both sides always inoperative. Deadbolt thrown or retracted by key either side. Auxiliary latch deadlocks latchbolt when door is closed. Specify per XL11-543.







In a double-door application where the dummy will be used as the strike order 10-091 Armored Front Strike separately.

*Caution: Double cylinder locks on residences and any door in any structure which is used for egress are a life safety hazard in times of emergency and their use is not recommended. Installation should be in accordance with existing codes only.

Lock Functions | Full Mortise Deadlocks

| | Schlage | ANSI |
|---|---|------------|
|  | L9460 | F17 |
| | Cylinder x Thumbturn Lock Deadbolt thrown or retracted by key outside or thumbturn inside. | |
|  | L9462 | F16 |
| | Double Cylinder Lock* Deadbolt operated by key from either side. | |
|  | L9463 | |
| | Classroom Lock Deadbolt thrown or retracted by key from outside. Inside thumbturn cylinder retracts deadbolt, but cannot project it. | |
|  | L9464 | F18 |
| | Cylinder Lock Deadbolt thrown or retracted by key from one side. No trim on opposite side. | |
|  | L9460 x XL11-635 | |
| | L9460 with Pull Knob/lever both sides fixed. Deadbolt thrown or retracted by key outside or thumbturn inside. | |
|  | L9460 x XL11-886 | |
| | Single Cylinder Deadlock with Pull Deadbolt thrown or retracted by key outside or thumbturn inside. No latch, but inside knob or lever is spring-loaded. Rotating inside knob/lever also retracts deadbolt. Fixed outside knob/lever. | |
|  | L9462 x XL11-886 | |
| | Double Cylinder Deadlock with Pull* Deadbolt thrown or retracted by key from either side. No latch, but inside knob/lever is spring-loaded. Rotating inside knob/lever also retracts deadbolt. Fixed outside knob/lever. | |
|  | L9464 x XL11-886 | |
| | Deadlock with Pull Deadbolt thrown or retracted by key from one side. No latch, but inside knob/lever is spring-loaded. Rotating inside knob/lever also retracts deadbolt. Fixed outside knob/lever. | |











Lock Functions | Small Mortise Deadlocks

| | Schlage | ANSI |
|---|--|---------------|
|  | L460 | E06071 |
| | Cylinder x Thumbturn Lock Deadbolt thrown or retracted by key outside or thumbturn inside. | |
|  | L462 | E06061 |
| | Double Cylinder Lock* Deadbolt operated by key from either side. | |
|  | L463 | E06091 |
| | Classroom Lock Deadbolt thrown or retracted by key from outside. Inside thumbturn cylinder retracts deadbolt, but cannot project it. | |
|  | L464 | E06081 |
| | Cylinder Lock Deadbolt thrown or retracted by key from one side. No trim on opposite side. | |
|  | L480 | |
| | Door Bolt Deadbolt thrown or retracted by thumbturn from one side. No trim on opposite site. | |
|  | L496 | |
| | Deadbolt with "Occupied" Indicator Deadbolt thrown or retracted by key outside or thumbturn inside. When deadbolt is thrown "Occupied" plate is displayed. (Previously XL11-911) | |







Schlage L-Series Universal Transformation Instructions

The L9050 universal case can be transformed into nine different functions* with just a few additional parts.

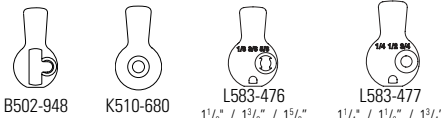
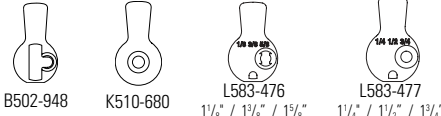
For some functions, additional parts are not necessary.

| ANSI Function | Function Type | Function Description |
|---------------|---|--|
| F04 |  L9050 (w/thumbturn) Office | Latchbolt operated by lever either side except when outside lever is made inoperative by a stop or other mechanical means other than key. When outside lever is locked, latchbolt is retracted by key from outside or by operating inside lever. Auxiliary deadlatch. |
| F01 |  L9010 Passage | Latchbolt operated by lever from either side at all times. |
| F05 |  L9070 Classroom | Latchbolt operated by lever either side except when outside lever is locked from outside by key or push button mechanism. When outside is locked latchbolt is retracted by key or by operating key or push button, and outside lever from outside or by operating inside lever. Auxiliary deadlatch. |
| F07 |  L9080 Storeroom | Latchbolt operated by key outside or by operating inside lever. Outside lever always inoperative. Auxiliary deadlatch. |
| F09 |  L9060 Apartment Entrance | Latchbolt operated by lever either side, except when made inoperative by key from inside. When outside is locked latchbolt is retracted by key from outside or by operating inside lever. Auxiliary deadlatch. |
| F31 |  L9080 (less outside cylinder) Exit or Communicating | Latchbolt operated by inside lever. Non-removable blank trim or no trim outside. |
| F32 |  L9071 Classroom Security | Latchbolt retracted by lever either side except when outside lever is locked by key from inside or outside. When outside lever is locked latchbolt is retracted by key either side or by inside lever. Auxiliary deadlatch. |
| |  L9080 (less outside lever) Service | Latchbolt operated by key outside or by operating inside lever. No outside lever. Auxiliary deadlatch. |
| |  L9080 (less inside trim) Utility | Latchbolt retracted by key outside; outside lever always inoperative. No inside trim. Auxiliary deadlatch. |
| |  L9070 (less inside trim) Closet | Latchbolt operated by lever on outside except when outside lever is locked from outside by key. When outside is locked latchbolt is retracted by key or by operating key from outside lever. Auxiliary deadlatch. |

* Assumes Everest cylinders and L9050 as base function (L283-133 Chassis/L9050LB Distributor Lock Case) — only applies to sectional trim (not escutcheon).

| Transformation Instructions | Additional Part(s) | |
|---|---|---|
| Install cloverleaf cam cylinder on outside; install thumbturn assembly 09-509-027 on inside. | No additional parts required. | |
| Do not install thumbturn unit 09-509-027 on inside or cylinder outside. Install chassis in the unlocked position. | No additional parts required. | |
| Install cloverleaf cam cylinder on outside; do not install thumbturn assembly 09-509-027 on inside. | No additional parts required. | |
| Do not install thumbturn 09-509-027 on inside. Install chassis in the locked position. Replace cloverleaf cam L583-153 with straight cam B502-948 (Everest), L583-255 with K510-680 (IC and SFIC) and install on outside. | Cams B502-948 (Everest), K510-680 (IC and SFIC) or L583-476 or L583-477 for modular cylinders |  B502-948 K510-680 L583-476 L583-477 <small>1 1/8" / 1 3/8" / 1 5/8" 1 1/4" / 1 1/2" / 1 3/4"</small> |
| Do not install thumbturn 09-509-027 on inside. Install cloverleaf cam cylinder on inside. Replace clover leaf cam L583-153 with straight cam B502-948 (Everest), L583-255 with K510-680 (IC and SFIC) and install on outside. | Mortise cylinder assembly and cams B502-948 (Everest), K510-680 (IC and SFIC) or L583-476 or L583-477 for modular cylinders |  B502-948 K510-680 L583-476 L583-477 <small>1 1/8" / 1 3/8" / 1 5/8" 1 1/4" / 1 1/2" / 1 3/4"</small> |
| Do not install thumbturn unit 09-509-027 on inside. Install chassis in the locked position. Install inside lever with L285-150 mounting plate; do not install outside lever or cylinder. | Mounting plate L283-150 |  L283-150 |
| Do not install thumbturn unit 09-509-027 on inside. Install cloverleaf cam cylinder on inside and outside. | Mortise cylinder assembly and cam L583-153 |  Mortise Cylinder Assembly L583-153 L583-274 L583-275 <small>1 1/8" / 1 3/8" / 1 5/8" 1 1/4" / 1 1/2" / 1 3/4"</small> |
| Do not install thumbturn unit 09-509-027 on inside. Install chassis in the locked position. Replace cloverleaf cam L583-153 with straight cam B502-948 (Everest), L583-255 with K510-680 (IC and SFIC) and install on outside. Install inside lever with L285-150 mounting plate; do not install outside lever. | Cams B502-948 (Everest), K510-680 (IC and SFIC), mounting plate L283-150 or L583-476 or L583-477 for modular cylinders |  L283-150 B502-948 K510-680 L583-476 L583-477 <small>1 1/8" / 1 3/8" / 1 5/8" 1 1/4" / 1 1/2" / 1 3/4"</small> |
| Do not install thumbturn unit 09-509-027 on inside. Install chassis in the locked position. Replace cloverleaf cam L583-153 with straight cam B502-948 (Everest), L583-255 with K510-680 (IC and SFIC) and install on outside. Install inside lever on outside with L283-150 mounting plate; do not install inside lever. | Cams B502-948 (Everest), K510-680 (IC and SFIC), mounting plate L283-150 or L583-476 or L583-477 for modular cylinders |  L283-150 B502-948 K510-680 L583-476 L583-477 <small>1 1/8" / 1 3/8" / 1 5/8" 1 1/4" / 1 1/2" / 1 3/4"</small> |
| Install cloverleaf cam cylinder on outside; do not install thumbturn assembly 09-509-027 on inside. Install inside trim on outside with L283-150 mounting plate. | Mounting plate L283-150 |  L283-150 |

Electrified Lock Function

Applications:

Security control centers, cashier rooms, fire safety exits, stairwell doors, telephone equipment rooms, computer rooms, hospital equipment and narcotics storage areas.

Regulating Devices:

Recognition Systems, Inc., HandReaders, wall switches, security consoles, access card readers, thermo-sensitive devices, smoke and fire alarms, telephone access controls, automatic time devices and computerized controls.

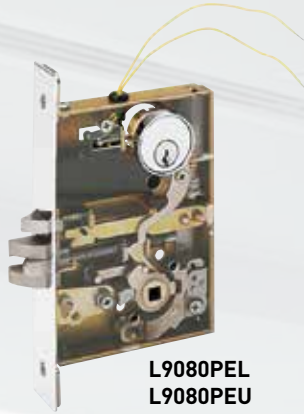

L9080PEL
L9080PEU
L9082PEL
L9082PEU

All installations should be in accordance with local electrical codes and National Electrical Code, NFPA 70.

Electrical Requirements for EL or EU

Voltage: 24V AC or 24V DC (maximum 26V, minimum 22V)
 Peak Current: Amps 1.3 at 5- to 10-second intervals
 Holding Current: Amps .135 between peak current intervals
 Operating Temperature: Maximum +151° F, minimum -31° F

Micro Switch Electrical Requirements for Request to Exit (RX) Function

Amps: 1.0
 Volts: 24 AC or DC
 Peak Load: Amps, 5; volts, 250 AC or DC

Replacement Kit

L283-053 – Solenoid and driver, EL or EU

Typical Wiring Diagram for Electrified L-Series Locks

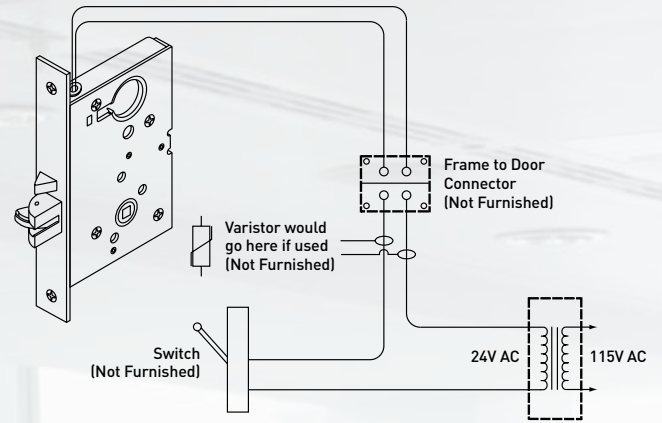

Typical Installation

- Electrified L-Series locks contain a transistorized circuit that provides full voltage to the solenoid upon initial application of electrical power and at 5- to 10-second intervals.
- Each lock should preferably have its own 24-volt transformer. Two or more locks may be operated in parallel from a single transformer, provided it has the necessary current rating.

NOTE: DO NOT connect locks in series from a higher voltage rated transformer.

- We DO NOT recommend that these locks be connected to a supply circuit that also contains electromagnetic devices. If an electromagnetic device is connected to the supply circuit, the resulting transient voltages could damage the lock. The transient voltage must be carefully suppressed at the equipment producing them before connecting the lock to the same circuit.
- A varistor rated at 35 volts (peak recurrent) may be used for transient voltage protection.

Cylinder Types

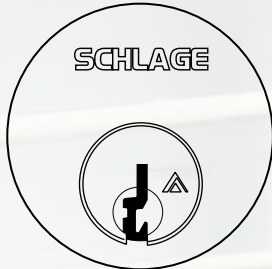

Standard Cylinders

Schlage locks are provided with cylinders precision-built to extremely close tolerances and the highest standards of accuracy. Using only solid brass bar stock plugs and shells, phosphor bronze springs, and nickel silver keys and bottom pins ensures long life and ease of operation. Our 6-pin Everest cylinders in C123 keyway with two patented keys are standard for stock. C145 is standard for new master key systems.

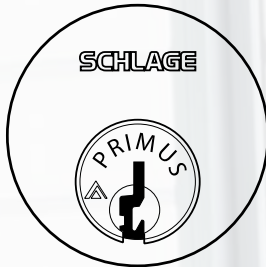

Primus® High Security Cylinders

Primus high-security cylinders are available to add patented key control and varying degrees of geographical exclusivity to most Schlage 6-pin key systems, whether Everest or Classic keyways. In addition to a conventional pin tumbler mechanism, Primus cylinders incorporate a patented finger pin and sidebar design, providing a "dual-locking" cylinder that is virtually pick-proof. Resistance to drilling and other physical attack is optional by specifying 20-500 Series UL437 Listed cylinders.

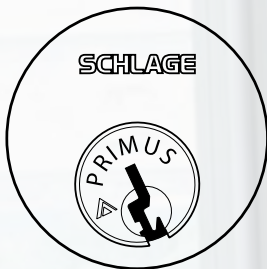

Primus Lockout Cylinders

For doors where it is frequently desirable to disable all keys from operating the lock temporarily use lockout cylinders. The special lockout key can be removed while the plug is turned to the 11 o'clock position, preventing all normal operating keys, including master keys, from fully entering the cylinder.

Suggested applications for lockout cylinders include laboratories, dark rooms, clean rooms and exterior doors to dormitories.

Schlage will not master key lockout cylinders.

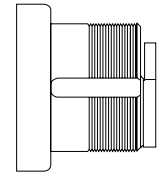
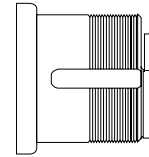
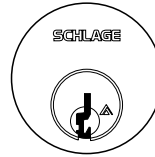

Standard (Non-IC) Cylinders

Standard (Non-IC) Mortise Cylinders

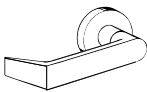
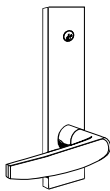
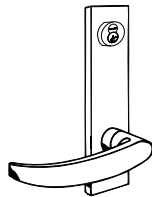

| Design | Function | Cylinder Mechanism | | | | |
|--|------------------------------|--------------------|--------|--------------|----------------|----------------------|
| | | Conventional | Primus | Primus UL437 | Primus Lockout | Primus UL437 Lockout |
| L & N Escutcheons (cylinders and spring only) | All Except Below | 30-021 | 20-793 | 20-593 | 20-717** | 20-517** |
| | L9060P Outside | 26-021 | 20-701 | 20-501 | 20-501 | 20-515** |
| | L9485, L9486 Hotel Functions | 30-022* | N/A | N/A | N/A | N/A |
| L Escutcheon with concealed shell cylinder (C suffix) | All Except Below | 30-004 | 20-789 | 20-589 | N/A | N/A |
| | L9080P Outside | 26-023 | N/A | N/A | N/A | N/A |
| | L9485, L9486 Hotel Functions | 30-005* | N/A | N/A | N/A | N/A |
| Sectional Trim and L400-Series (cylinder with compression ring & spring) | All Except Below | 30-001 | 20-787 | 20-587 | 20-717 | 20-517 |
| | L9060P Outside | 20-001 | 20-700 | 20-500 | 20-715 | 20-515 |
| | L9060P Outside | 30-002* | N/A | N/A | N/A | N/A |

* Specify door hand for hotel function cylinders.

** Discard compression ring for Lockout cylinders with escutcheon trim.

Finishes: 605, 606, 611, 612, 613, 619, 625, 626, 629 and 630.

Concealed shell cylinders available in 606 and 626 only.

6-pin Everest C123 keyway standard for stock cylinders; C145 standard for new key systems.

Standard cylinder lengths: sectionals (rose) trim = 1 1/8" (29 mm), escutcheon trim = 1 1/4" (32 mm).

Optional cylinder lengths are in 1/8" (4 mm) increments ranging from 1 1/8" to 1 3/4" (29 mm to 44 mm).

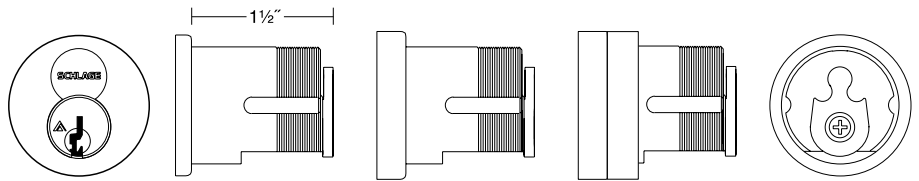

Full-Size Interchangeable Core Cylinders

Schlage figure-8 interchangeable core (IC) cylinders allow immediate rekeying at the door. Simply use the special control key to replace the core in seconds. Full-size IC cylinders can be integrated into any existing 5- or 6-pin Schlage key system with no adverse effects on keying capacity. Convert existing mortise locks to interchangeable core merely by replacing the old cylinder with the IC cylinder and proper collar(s).

For ordering information see page 35.

Full-Size IC Mortise Cylinders

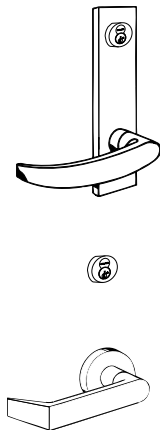

| Design | Function | Core Mechanism | | |
|--|-----------------------------------|----------------|--------|------------------------------|
| | | Conventional | Primus | Primus UL437 |
| L & N Escutcheons (cylinders with compression ring) | All Except Below | 30-008 | 20-798 | 30-007 |
| | L9060P Outside | 30-030 | 20-782 | 30-032 + 36-083 |
| | L9485P, L9486P Hotel Functions | 30-010* | N/A | 30-007 |
| Sectional Trim and L400-Series (cylinder with compression ring, spring and 3/8" blocking ring) | All Except Below | 30-138 | 20-776 | 30-137 |
| | L9060P Outside | 20-061 | 20-783 | 30-032 + 36-083 + 35-082-037 |
| | L9485P, L9486P Hotel Functions | 30-140* | N/A | N/A |

* Hotel function cores are handed. Specify hand of door. Finishes: 605, 606, 611, 612, 613, 619, 625, and 626. Standard cylinder length is 1 1/2".

Full Size Interchangeable Cores Only

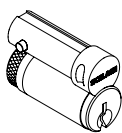

| Number | Description |
|--------|--|
| 23-030 | Conventional core |
| 20-740 | Primus high-security core |
| 30-120 | Hotel function core (Specify hand of door) |

Available 606 and 626 finish only.
Standard keyway: 6-pin Everest C123 for stock, C145 for new master key systems

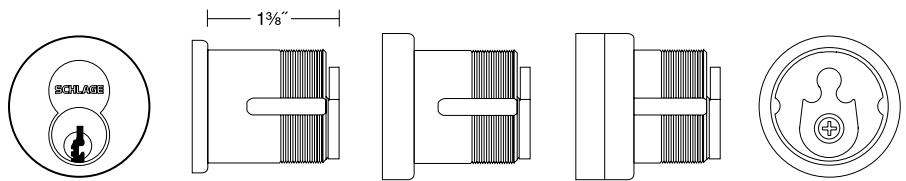

Small Format Interchangeable Core (SFIC) Cylinders

The L-Series lockset can be ordered to accept small format interchangeable cores (SFIC) compatible with manufacturers such as Falcon, Arrow and Best; cams are easily changeable.

To order Schlage L-Series mortise locks with SFIC cylinders less core, change suffix P to BD. Example: L9453BD. To order locks with Everest B Family restricted keyway cores, change suffix to GD. To order with keyed construction cores, change suffix to HD. To order with disposable construction cores, change suffix to BDC.

For ordering information see page 35.

Standard (Non-IC) Mortise Cylinders



| Design | Function | Core Mechanism | | | |
|--|---------------------------|--------------------------------|--------------------------------|--------------------------------------|-------------------------------|
| | | Everest Restricted (GD Suffix) | Keyed Construction (HD Suffix) | Disposable Construction (BDC Suffix) | Housing Less Core (BD Suffix) |
| L & N Escutcheons (cylinders with compression ring and spring) | All* except L9060 Outside | 80-308 | 80-138 | 80-115 | 80-108 |
| | L9060 Outside | 30-030 | 20-782 | 30-032 + 36-083 | 80-104 |
| Sectional Trim and L400-Series (cylinder with compression ring, spring and 1/4" blocking ring) | All* except L9060 Outside | 30-138 | 20-776 | 30-137 | 80-101 |
| | L9060 Outside | 80-304 + 36-082-025 | 80-134 36-082-025 | 80-112 36-082-025 | 80-104 36-082-025 |

Finishes: 605, 606, 611, 612, 613, 619, 625, and 626.
Standard cylinder length is 1 3/8".

Small Format Interchangeable Core Only

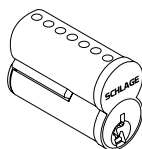

| Number | Description |
|--------|--|
| 80-036 | 7-Pin uncombined Everest B Family restricted keyways |
| 80-037 | 7-Pin combined Everest B Family restricted keyways |
| 80-043 | 6-Pin uncombined Falcon / Best keyways |
| 80-033 | 7-Pin uncombined Falcon / Best keyways |

Available 606 and 626 finish only. Specify keyway for existing systems.
80-033 and 80-043 cores are available in A, D, E, F, G, H, J, K, L, and M keyways.
Schlage assigns the keyway when establishing new Everest restricted key systems.

Blocking and Compression Rings

36-079



Blocking Ring. Specify finish and dimension. Not to be used with 36-083.

36-082



Blocking Ring. Specify finish and dimension. Use with 36-083.

36-083

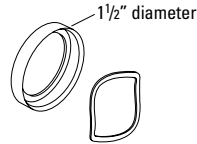

Compression Ring and Spring. Specify finish and dimension.

L538-195



Compression Spring.

Dimensions for Blocking Rings

| Blocking Ring Length | Dimension |
|----------------------|-----------|
| 1/8" | 012 |
| 3/16" | 018 |
| 1/4" | 025 |
| 5/16" | 031 |
| 3/8" | 037 |
| 7/16" | 043 |
| 1/2" | 050 |

Full-Size Core Blocking Ring Requirements

| Function | Trim | Door Thickness | | | |
|---|------------|----------------|--------|-----|--------|
| | | 1 3/8" | 1 3/4" | 2" | 2 1/4" |
| | | Dimension | | | |
| L9050, L9070, L9080, L9410 (disc), L9453, L9456, L9460 per XL11-886 or XL11-635, L9464 per XL11-886, L9465, L9473, L9480, L9496 | Rose | 050 | 037 | 025 | 025 |
| | Escutcheon | 025 | 012 | N/R | N/R |
| L9485 | Rose | — | 037 | 025 | 025 |
| | Escutcheon | — | 012 | N/R | N/R |
| L9486 | Rose | 012 | N/R | N/R | N/R |
| | Escutcheon | 025 | 012 | N/R | N/R |
| L9060, L9071, L9077, L9082, L9457, L9462 per XL11-886, L9466, L9482 | Rose | — | 050 | 043 | 031 |
| | Escutcheon | 025 | 012 | N/R | N/R |
| L460, L464, L496, L9460, L9464 | Rose Trim | 050 | 037 | 025 | 025 |
| L462, L463, L9462, L9463 | Rose Trim | — | 050 | 043 | 031 |

Full-Size Core Blocking Ring Requirements

| Function | Trim | Door Thickness | | | |
|--|------------|----------------|--------|-----|--------|
| | | 1 3/8" | 1 3/4" | 2" | 2 1/4" |
| | | Dimension | | | |
| L9050, L9060, L9070, L9071, L9077, L9080, L9082, L9453, L9456, L9457, L9462 per XL11-886, L9465, L9466, L9473, L9482 | Rose | 037 | 025 | 012 | N/R |
| | Escutcheon | N/R | N/R | N/R | N/R |
| L9050, L9060, L9070, L9080, L9082, L9410 (disc), L9453, L9456, L9460 per XL11-886 or XL11-635, L9464 per XL11-886, L9465, L9466, L9473, L9480, L9496 | Rose | — | 050 | 037 | 025 |
| | Escutcheon | 018 | N/R | N/R | N/R |
| L460, L464, L496, L9460, L9464 L462, L463, L9462, L9463 | Rose Trim | 037 | 025 | 012 | N/R |
| | Rose Trim | — | 050 | 037 | 025 |

Classroom Thumbturn Cylinders

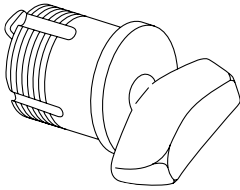

These cylinders are for L463 and L9463 classroom function deadlocks. They are handed. They have a rotational stop in one direction to prevent locking from the inside, but allow unlocking. Cylinders are field-reversible by changing the position of the rotational stop. All cylinders furnished with L583-254 cam.

| Number | Collar(s) |
|--------|--|
| 09-900 | None |
| 09-904 | Compression ring and spring |
| 09-905 | For 1 ³ / ₄ " doors: compression ring, spring and 1/8" blocking ring |
| 09-907 | For 1 ³ / ₄ " doors: compression ring, spring and 1/8" blocking ring |

Specify hand of door and finish. 1¹/₈" length standard. 09-900 and 09-905 also available in 1/8" increments up to 1³/₄".

Mortise Cylinder Cams

Most Functions

L400 and L9000 Series



L583-153
Everest and
Primus



L583-254
Classic
Conventional



L583-255
All IC

L9060 Outside Only



B502-948
Everest and
Primus



B502-191
Classic
Conventional



K510-680
All IC

Cams Screws



- B502-942 Everest and Primus (non-IC)
- B502-468 Classic Conventional (non-IC)
- L583-333 All full-size interchangeable core
- B520-484 All small format interchangeable core

IC Installation Tool

This tool is used to install and remove mortise cylinder housings and test mortise cylinder cam action for both small format and full-size interchangeable core cylinders. Its other ends are designed to install the driver and retainer for full-size IC in Schlage key-in-knob/lever locksets.

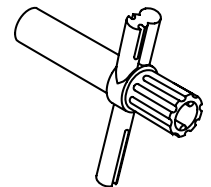

M504-413
(Order as needed)

Armored Fronts

L-Series armored fronts are produced from brass, bronze or stainless steel material, finished to match lock trim and furnished complete with screws. Numbers for ordering separately or with locks are listed below. Armored fronts are specified in latch column of order form.

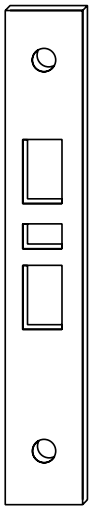

Standard Square Corner
1 1/4" (32 mm) width

| Square Corner | | Description |
|---------------------|----------------------|---|
| 1 1/4" (32mm) Width | 1 1/16" (27mm) Width | |
| 09-662 | 09-668 | Latch: L9010, 9040, 9044 |
| 09-663 | 09-669 | Deadlatch: L9050, 9056, 9060, 9070, 9071, 9080, 908 |
| 09-664 | 09-670 | Latch x deadbolt: L9444, 9456, 9457, 9465, 9466, 9473, 9496 |
| 09-665 | 09-671 | Deadbolt: L9460, 9462, 9463, 946 |
| 09-666 | 09-662 | Deadlatch x deadbolt: L9453, 9480, 9485, 948 |
| 09-661 | 09-667 | Blank (no holes): L9175, L917 |
| 09-713 | ---- | Deadlatch, non-UL: L9076, 9077 (holdback functions) |
| 09-717 | ---- | Deadbolt: L400-Series |

Note: For 1 3/8" (35mm) doors, 1 1/16" (27mm) front should be specified.

Strikes

All L-Series strikes are produced from brass, bronze or stainless steel material, finished to match lock trim, and furnished complete with screws. Numbers for ordering separately or with locks are listed below.

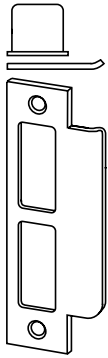

Standard for L9000
10-072
1 1/4" x 4 7/8"
x 1 3/16" Lip
32 mm x 124 mm
x 30 mm

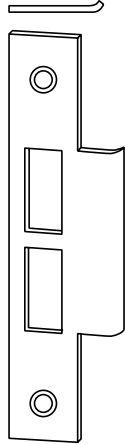

Armored Front Strike
10-091
1 3/4" x 8" x 1 3/16" Lip
32 mm x 203 mm
x 30 mm

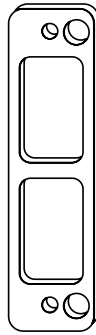

Wood Frame Reinforcer
37-015

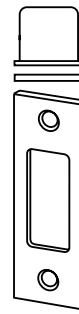

Standard for L400
10-079
1 1/8" x 3 1/2"
32 mm x 89 mm



Optional for L400
10-078
1 1/4" x 4 7/8"
32 mm x 124 mm

| Number | Lip Length | Description |
|----------|--|--|
| 10-072 | 1 3/16" (30mm) | L9000 Standard |
| | 7/8" (22mm), 1" (25mm), 1 1/2" (38mm) | L9000 Optional |
| | 1 3/4" (44mm), 2" (51mm) | L9000 Special lip |
| 10-073 | No Lip | L9460-Series deadlocks |
| 10-075 | No Lip | 1/2" (13mm) Rabbeted (use with 1 1/16" (27mm) armor) |
| 10-078 | No Lip | 1 1/4" x 4 7/8" with box, L400 optional |
| 10-079 | No Lip | 1 1/8" x 3 1/2" with box, L400 standard |
| 10-091* | 1 3/16" (30mm) | Armored front strike, no box |
| K510-053 | --- | Strike box for 10-079 |
| K10-066 | --- | Strike box, all except 10-079 |

*Specify hand of inactive leaf.

Door Handing

One of the revolutionary features of the L-Series mortise lock is that handing can be done by the distributor or installer quickly and easily without opening the lock case. This feature allows a Schlage distributor to order L-Series locks as stock and customize the handing to each order's specification. This means off-the-shelf delivery to meet today's fast-track construction requirements. These mix-and-match lever-with-knob combinations, along with a quickly reversible lock chassis, provide the ultimate in stocking, ordering and installation flexibility. Orders can be filled from stock, minimizing delivery problems.

Changing Lock Hand

No more than two simple steps are required to change the hand of any L-Series lock. Rotate the latch unit 180° and/or change the catch screw position.

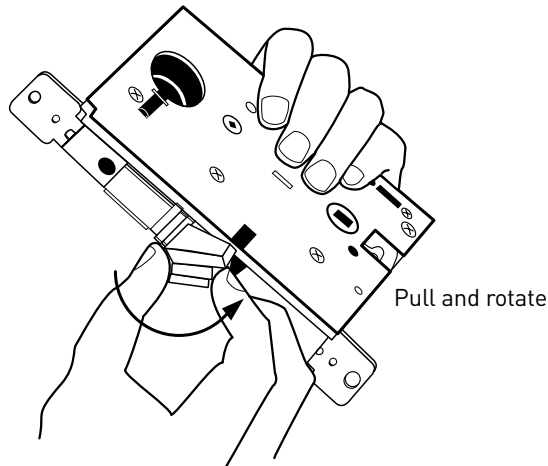

A. Changing Latchbolt Handing

Remove armored front. Pull latchbolt away from chassis and rotate complete unit 180° to reverse the door handing. Reinstall armored front.

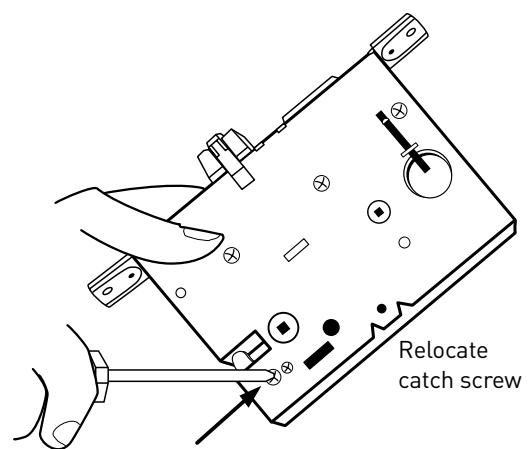

B. Change Chassis Handing

Remove catch screw from one side of chassis and install on opposite side. For RH and RR, the catch screw will be on the lock case side. For LH and LR, the catch screw will be on the lock case cover.

*Catch screw location reversed for Vandgard function. For first time users, an instructional video is available.

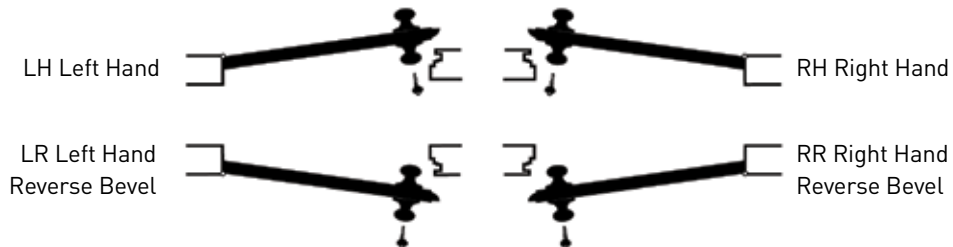

The hand is determined by the direction the door swings when viewed from the exterior or corridor side of the door.

Specifications

Handing:

L9000-Series lock bodies are field-reversible without disassembly.
L400-Series locks are non-handed.

Door Thickness:

1³/₄" (44 mm) standard. 1³/₈" (35 mm) to 2¹/₂" (64 mm) optional. Over 2¹/₂" (64 mm) door ranges vary by function. No escutcheon available for 1³/₄" (44 mm) doors standard. 2" to 2³/₈" (51 mm to 60 mm) optional. Specify door thickness if other than 1³/₄".

Backset:

2-3/4" (70 mm) only.

Armored Front:

L9000-Series: 1¹/₄" x 8" x 7/32" (32 mm x 203 mm x 6 mm) standard.
1¹/₁₆" x 8" x 17/32" (27 mm x 203 mm x 6 mm) optional.
L400-Series: 4⁷/₁₆" x 3⁵/₈" x 1" (113 mm x 92 mm x 25 mm)

Case Size:

L9000-Series: 4⁷/₁₆" x 6¹/₁₆" x 1" (113 mm x 154 mm x 25 mm)
L400-Series: 4⁷/₁₆" x 3⁵/₈" x 1" (113 mm x 92 mm x 25 mm)

Spacing:

Knob or lever to cylinder, 3⁷/₈" (98mm); knob or lever to thumbturn hub, 2¹/₁₆" (68mm).

Bolts:

1" (25mm) throw stainless steel deadbolt and 3/4" (19mm) throw stainless steel latch with anti-friction tongue.

Exposed Trim:

Knobs: #41 and #42 heavy-duty wrought brass, bronze or stainless steel knobs match D-Series knobs.

Levers: Forged brass or bronze and cast stainless steel. Designs available to match D-Series levers.

93 Lever Design: Extruded brass, bronze or stainless steel.

Mediterranean Designs: Forged-brass lever and rose.

Escutcheons: L escutcheons are cold-forged brass or bronze and stainless steel. N escutcheons are heavy wrought reinforced brass, bronze and stainless steel.

Trim Combinations: Available with knob both sides, lever both sides, or knob and lever with rose or escutcheon both sides.

Strike:

L9000-Series: ANSI curved lip strike 1¹/₄" x 4⁷/₈" (32 mm x 124 mm) x 1³/₁₆" (30 mm) lip to center with dust box standard. L400-Series: 1¹/₈" x 3⁵/₈" (29 mm x 92 mm) with dust box.

Cylinder & Keys:

6-pin Everest C123 keyway cylinder with two patented keys standard.

Keying Options:

Interchangeable core and Primus high security cylinders. Master keying, grand master keying and construction keying.

Certifications

ANSI:

L9000: ANSI A156.13 Series 1000, Grade 1 Operational and Security, UL Listed for 3-hour fire door (except L9076 and L9007). With interchangeable core cylinders: Grade 2 Security.

With Concealed Shell Cylinder: A156.13 Grade 1 Operational and Security. ANSI/ASTM F476-76 Grade 40, UL Listed. L400: ANSI A156.5 Grade 1

California State Reference Code:

(Formerly Title 19, California State Fire

Marshal Standard) All levers with returns

comply; levers return to within 1/2" of door face.

UL / cUL:

All locks listed for A label single doors, 4' by 10'. Letter F and UL symbol on latch front indicate listing. Electrified functions are UL19X Listed for single-point locking applications. UL437 Listed locking cylinder optional: specify Primus 20-500 Series cylinder.

Door Preparation for L9000 Series

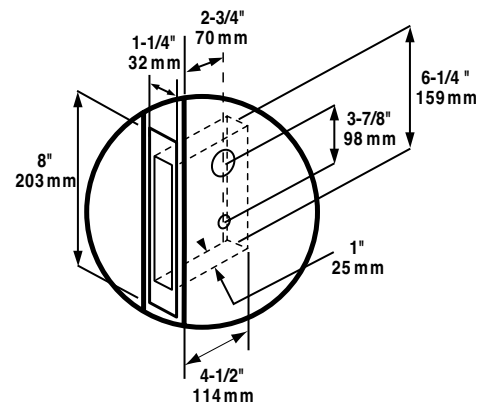

Door Preparation for L400 Series

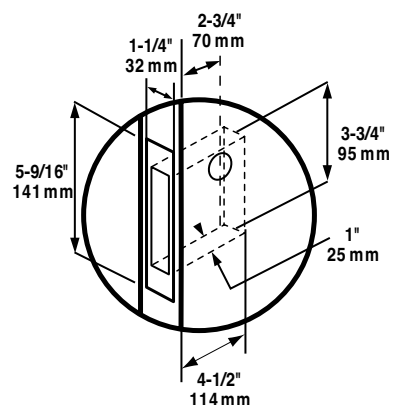

How to Order

To order Schlage products, descriptive data should be in the same sequence as shown.

| Line Item | Qty | Product | Outside | | Inside | | Hand | Front | Strike | Door Thickness | Ext | Dim | Additional Details |
|-----------|-----|---------|---------|-----|--------|-----|------|-------|--------|----------------|-----|-----|--------------------|
| | | | Des | Fin | Des | Fin | | | | | | | |
| 1 | 2 | 3 | 4 | 5 | 6 | 7 | 8 | 9 | 10 | 11 | 12 | 13 | 14 |

- 1 Line item number
 - 2 Quality
 - 3 Complete model number with function and cylinder type
- To order cylinder options, change "P" at the end of the model number as follows:



- L9453P Standard
- L9453L Less standard cylinder. For Primus cylinder, specify this option and order Primus cylinder separately.
- L9453C With temporary plastic construction cylinder. Double cylinder functions ordered less cylinder are furnished with these construction cylinders to maintain timing of key cams.



- L9453J Prepared for full size interchangeable core, less core. For Primus core, specify this option and order Primus core separately.
- L9453R With full-size conventional interchangeable core installed. Order control keys separately.
- L9453T With full-size (temporary) construction core installed. Order all keys separately.



- L9453BD Prepared for small format (Falcon, Best, etc.) interchangeable core (SFIC), less core.
- L9453GD With Everest B Family restricted keyway small format core installed. Order control keys separately.
- L9453HD With small format keyed brass construction core installed. Order all keys separately.

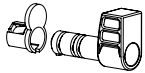

- L9453BDC With small format disposable plastic construction core installed.

- 4/5 Outside design / finish. Specify tactile warning (knurling) here as "8" before lever design, e.g. 803. To specify complete design, combine the numeric knob or lever design with the alpha rose or escutcheon design. Example: 03L, 93A, 42B. When ordering Mediterranean design levers with L escutcheons, specify AST/00L, AVA/00L or MER/00L.
- 6/7 Inside design/finish. Leave blank if same as outside.
- 8 Hand. One hand per line item.
- 9 Front (use "Strike" field on Schlage form). Leave blank for standard armored front or enter number for narrow front.
- 10 Strike. Leave blank for standard or specify part number for optional strike. LLL = Less Strike.
- 11 Door thickness, if non-standard. Example: 200 = 2".
- 12 Extension, to specify whether thick door is extended inside (EI), outside (EO), differently (ED) or equally (EE).
- 13 Dimension for strike lip lengths. See strike page for availability of specific dimensions with specific strikes.

| | | | |
|--------------|--------------|--------------|----------|
| 100 = 1" | 114 = 1 1/4" | 112 = 1 1/2" | 200 = 2" |
| 118 = 1 1/8" | 138 = 1 3/8" | 134 = 1 3/4" | |

- 14 Keying detail (e.g. key symbol, keyway, bitting) and other special requirements.

Example

| Line Item | Qty | Product | Outside | | Inside | | Hand | Front | Strike | Door Thickness | Ext | Dim | Additional Details |
|-----------|-----|---------|---------|-----|--------|-----|------|--------|--------|----------------|-----|-----|--------------------|
| | | | Des | Fin | Des | Fin | | | | | | | |
| 1 | 50 | L9453P | 03A | 626 | | | RH | | 10-091 | | | | |
| 2 | 50 | L9453P | 03A | 626 | | | LH | | 10-091 | | | | |
| 3 | 10 | L9040 | 03A | 626 | | | RH | | | 138 | | | |
| 4 | 10 | L9040 | 03A | 626 | | 625 | LH | 09-668 | | 138 | | | |
| 5 | 50 | L9456P | 07L | 626 | | 625 | RH | 09-668 | | | | | |
| 6 | 50 | L9456P | 07L | 626 | | | LH | | | | | | |

Note: Schlage order forms are available at no charge by contacting your IR Security & Safety Consultant or Customer Service.



Ingersoll Rand (NYSE:IR) advances the quality of life by creating and sustaining safe, comfortable and efficient environments. Our people and our family of brands—including Club Car®, Ingersoll Rand®, Schlage®, Thermo King® and Trane®—work together to enhance the quality and comfort of air in homes and buildings; transport and protect food and perishables; secure homes and commercial properties; and increase industrial productivity and efficiency. Schlage is the leader in security devices, trusted for 90 years, spanning both the commercial and residential markets. Ingersoll Rand is a \$14 billion global business committed to a world of sustainable progress and enduring results.



securitytechnologies.ingersollrand.com

ingersollrand.com