

Locking Pull Installation Instructions For All Glass Doors

UNPACKING INSTRUCTIONS

Save all fasteners as they are needed for installation

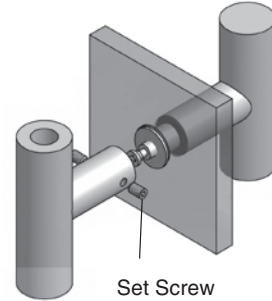
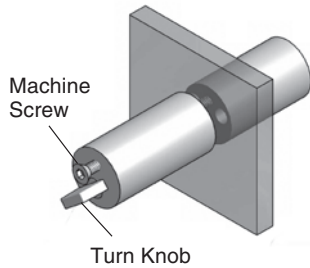

1. Rotate turn knob $\frac{1}{4}$ turn to allow removal of socket head machine screw.
2. Unscrew the socket head machine screw in the lock housing.

3. Loosen set screws on the side of the mounting post(s) at the end of the pull.
4. Separate interior (turn knob side) pull from exterior pull.
5. Remove conehead machine screw from end mounting post(s).

INSTALLATION INSTRUCTIONS (Steps 1-3)

Step 1 - Install Exterior Pull

1. Verify center to center of mounting holes is correct.
2. Insert clear bushings into $\frac{5}{8}$ " hole(s) in glass door.
3. Put metal washer followed by plastic washer onto conehead screw and then through the door onto another plastic washer and into the end mounting post(s) of the exterior pull.
4. Place cork washer under the lock housing.
5. Holding the pull in place, tighten conehead machine screw(s) at the end post(s) completely.

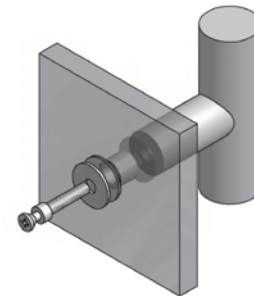
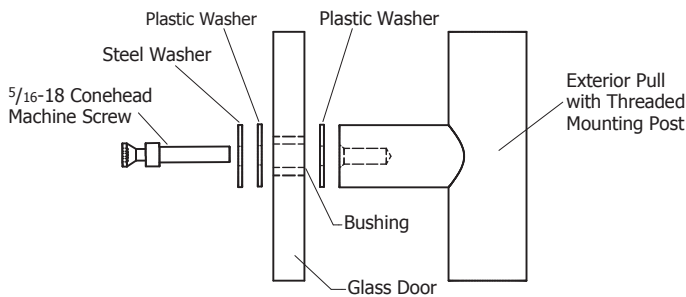

Step 2 - Preparing for Interior Pull Installation

1. Rotate the turn knob counter-clockwise to completely retract (unlock) the bolt.
2. Remove key from cylinder of exterior pull.
3. Rotate shaft counter-clockwise until it stops.

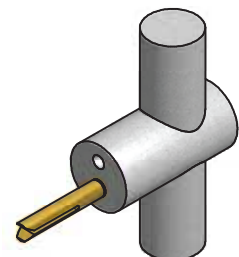
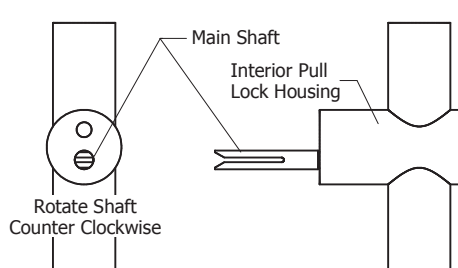

Step 3 - Installing Interior Pull

1. Insert garolite bushing into $1\frac{3}{16}$ " hole in glass door.
2. Place cork washer under lock housing.
3. Position pull for installation and slide main shaft through door into mating hole on the exterior pull lock housing.
4. At the same time slide the end mounting post(s) over the conehead head(s).
5. Tighten the set screws in the end mounting post(s).
6. If necessary, rotate the turn knob $\frac{1}{4}$ turn to allow access to lock housing mounting screw hole.
7. Insert the socket head machine screw into the turn knob lock housing and tighten completely.
8. Return the turn knob counter-clockwise to the completely retracted position.

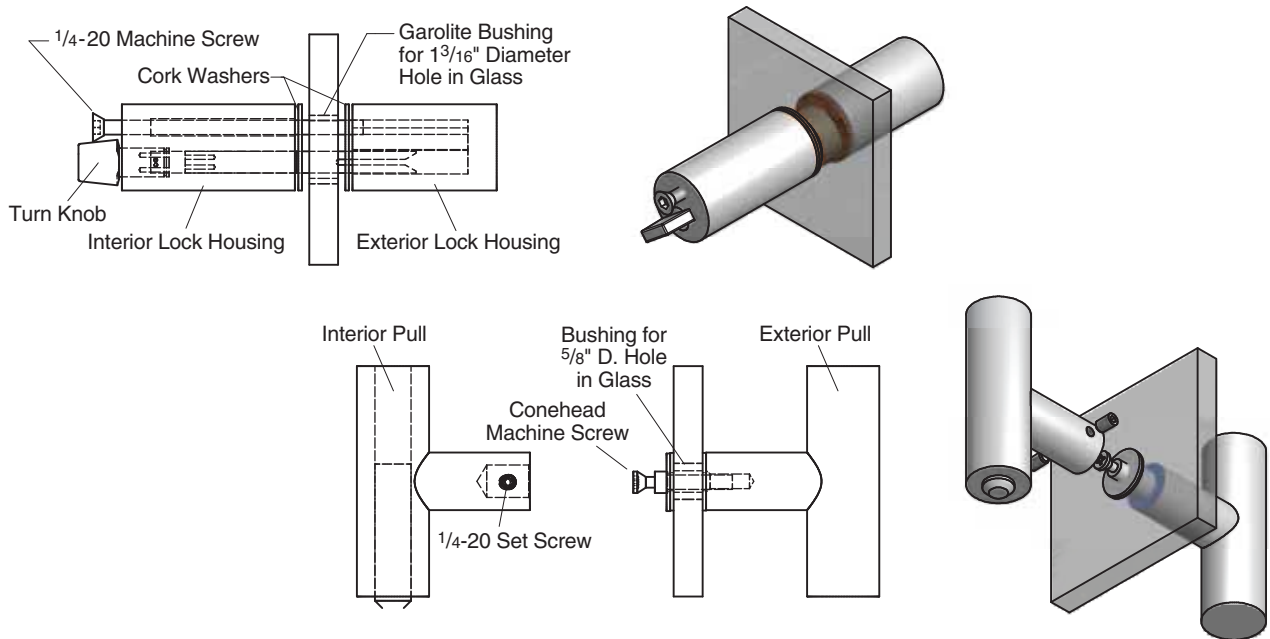

Top Strike Installation

1. Position strike in proper location on underside of head as appropriate so that the bolt engages the hole in the strike.
2. Mark screw hole locations.
3. Drill hole with #3 drill and tap $\frac{1}{4}$ -20.
4. Attach strike with included screws.
5. Adjust stop if included. (Cased opening, single acting only.)

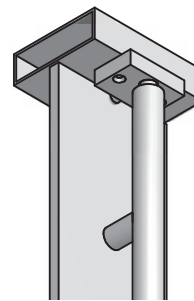

Bottom Strike Installation

1. Locate strike in proper location on floor or threshold as appropriate so that the bolt engages the hole in the strike.
2. Follow mounting instructions for #570 dust proof strike (included with strike).

