

614V Door Knocker

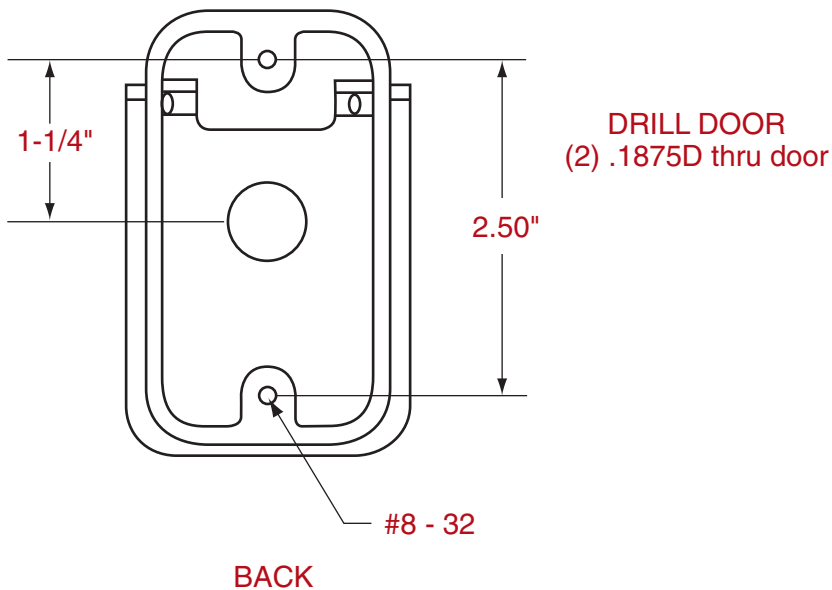
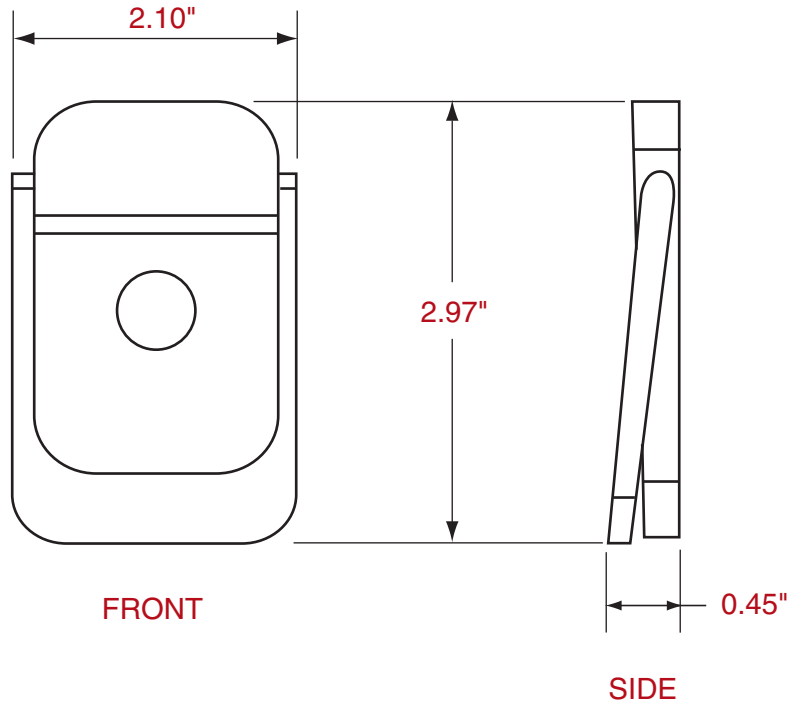

FORGING BRASS MATERIAL

Not To Scale

Template No.
T-614V
Rev. 9/7/11

NOTE: Rockwood reserves the right to make product changes and is not responsible for obsolete template errors. To ensure your template is current, please visit our website at www.rockwoodmfg.com or call us at 800-458-2424.