

K 4712

design Valli Workshop







Material Brass/Materiale Ottone

Product Submittal

Custom finishes available
 Spring assist built in rosette
 Passage, privacy, dummy, multipoint, mortise hardware available
 Accommodates all standard and some custom backset dimensions
 A complete selection of other matching hardware may be available



Ecostile Door levers/Maniglia

Finish		
 03	RT	
 06B	RT	
 26	RT	
 26D	RT	

Finishes
 03= Polished Brass
 06B= Brunito
 26= Polished Chrome
 26D= Satin Chrome

Functions
 PGE= passage
 PCY= privacy
 DMY= dummy
 ML-F= mortise lock
 MULTI-POINT TRIM

Trim Options
 RT= standard traditional style rosette
 ET= traditional style long escutcheon plates
 ER= rectangular style long escutcheon plates

Sizes/Misure

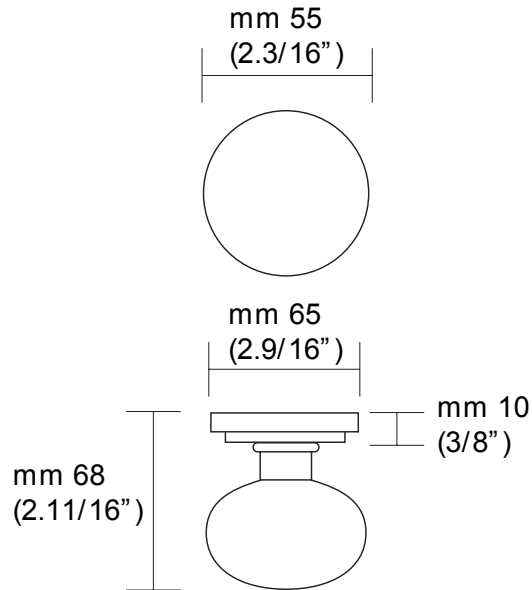

Valli&Valli U.S.A. Inc.
 Architects and Designers Building
 964 Third Ave., Suite 563/Annex
 New York, NY 10155
 sales@allivalli-us.com
 T 212 326 8811
 F 212 326 8816
 Toll Free 877 326 2565

To order Valli&Valli products, informations should be specified in the same sequence as the example given:

1.Lever/Knob	2.Trim options	3.Function	4.Finish	5.Handing	6.Backset	7.Miscellaneous
H136	RT	ML F	03	RH	2-1/2"	2-1/4" thick

For small rosette, please specify RS (45 mm rosette). RS pricing is the same as RP/RT pricing. Privacy RS also requires 105 RSP when ordering. RQ (2.9/16" rosette) for standard 2.1/8" cross bore.

820 S. Rockefeller Avenue,
 Suite E
 Ontario, CA 91761
 w.sales@allivalli-us.com
 T 909 390 0333
 F 909 390 0353
 Toll Free 800 423 7161