

Universal Z Door Check

The Reasonable Model for All Interior Doors

The Z door check is the best value model of all DICTATOR door dampers. Due to its small size it is particularly suitable for interior doors.

The Z door damper is available in 3 different models: Z 1000, ZF and Z 1100. The ZF model is mainly used in France. Contrary to the Z 1000 and the ZF for hinged doors, the Z 1100 is designed for sliding doors. Usually the Z 1100 for sliding doors is used only with a 20 N spring to keep the force needed for opening as low as possible.

The Z door check is designed for vertical mounting.

It can be used for right and left operating doors. The three different hooks available allow Z door dampers to be mounted onto overlapping, flush or recessed doors.

By default the Z door checks are manufactured with nickel-plated or zinc-plated finish. There are not available colour coated or stainless steel models.



Technical Data

Types of doors	hinged doors: left and right operating, overlapping, flush, recessed sliding doors: Z 1100
Closing force	20, 50 or 80 N (measured on the door damper)
Damping characteristics	progressive, adjustable closing speed
Damping fluid	silicone oil, almost independent of temperature
Components included	door damper, hook, screws
Finish	nickel-plated, zinc-plated



DICTATOR Z 1000 Door Check

Cost-Effective Standard Model for All Interior Doors

The DICTATOR Z 1000 door damper is mainly used on interior doors. It is the standard model of the Z range. Due to its universal fixing holes it also replaces the models ZF, ZU and ZT.

The Z 1000 door check is available with different hooks for flush (1009), recessed (1011) and overlapping doors (1013) (see dimensioned drawing: maximum lintel projection 22 mm, maximum thickness of rebate 30 mm).

Dimensions

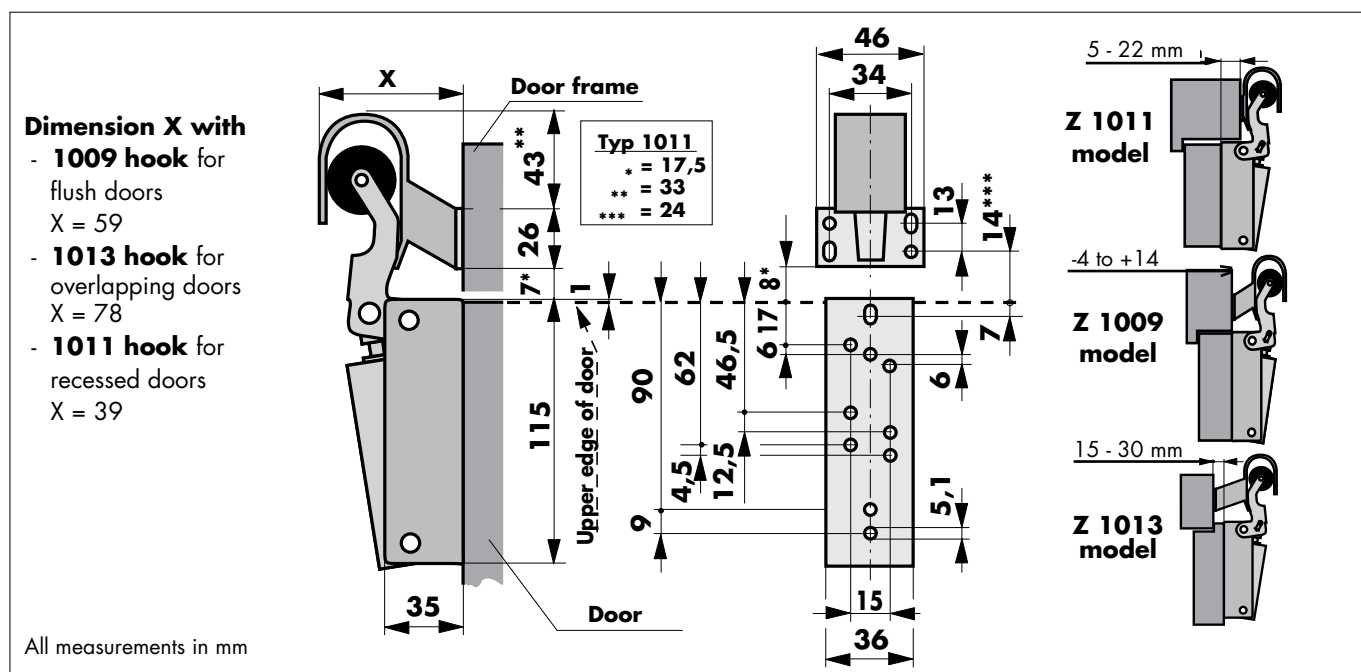

Mounting

Mark the oblong hole of the casing about 40 cm from the closing edge of the door. The upper edge of the casing should overlap the upper edge of the door by about 1 mm. Now screw the door damper vertically to the front of the door (see drawing). Fix the hook to the door frame so that the rubber roller on the operating lever passes just below the front edge of the hook. Finally fix the cylinder with the bolt to the casing of the door damper.

Order Information

(Further types on request)

Note:

** Available on request

Hook type	1009	1011	1013
Z 1000 door check, 20 N, nickel-plated	**	300374L	**
Z 1000 door check, 20 N, zinc-plated	300907	**	**
Z 1000 door check, 50 N, nickel-plated	300373	300374	300375
Z 1000 door check, 50 N, zinc-plated	300904	300905	300906
Z 1000 door check, 80 N, nickel-plated	300913	300914	300915
Z 1000 door check, 80 N, zinc-plated	300368	**	300366



DICTATOR ZF Door Check

Special Design for France

The former DICTATOR ZF/ZU door dampers have completely been replaced by the Z 1000 door damper. The fixing holes on the Z 1000 have been completed accordingly.

However the ZF door damper part no. 300147 is an exception. The dimensions of its casing and the operating lever differ from those of the Z 1000. It is especially designed for France and serves mainly for replacement.

It is always supplied with the 1011 hook for recessed doors.

Dimensions

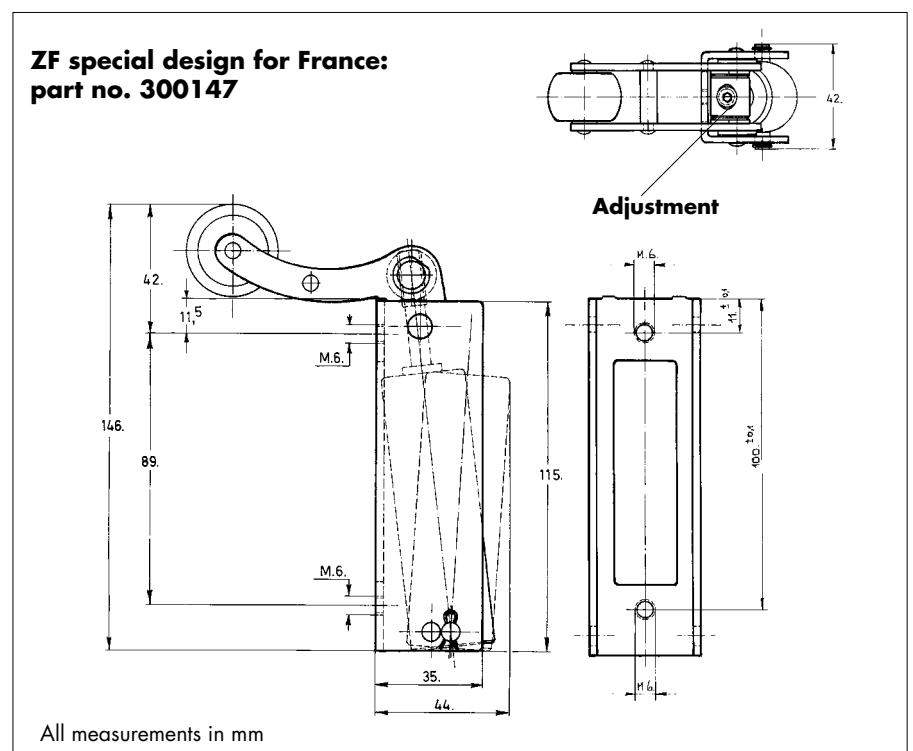

Mounting/Adjustment

The mounting instructions for the Z 1000 also apply for the ZF (see preceding page).

The closing speed and damping of the ZF is adjustable. Due to the conical interior of the damping cylinder, the closing movement is increasingly slowed the further the piston enters the cylinder. To achieve a higher damping (slower closing speed) turn the piston rod clockwise with a hexagon socket screw key (see "Adjustment" in drawing). Turning it anti-clockwise will reduce the damping (higher closing speed). Two complete rotations correspond to a 1 second increase or decrease of the closing speed.

Order Information

ZF door check, hook 1011, 50 N, zinc-plated

part no. 300147



DICTATOR Z 1100 Door Check

For Room Sliding Doors

The DICTATOR Z 1100 door damper is a special version of the Z 1000 with mounting bracket designed for room sliding doors. The Z 1100 door damper slows down the closing speed on the last few centimetres and closes the sliding door completely. Especially with lightweight room doors this represents the ideal solution as normal final dampers, due to their integrated return spring (see Damping Engineering of our catalogue), might re-open these doors a little bit under unfavourable conditions.

The Z 1100 door damper comes with the 1009 hook (see page 02.014.00 for dimensions).

Dimensions

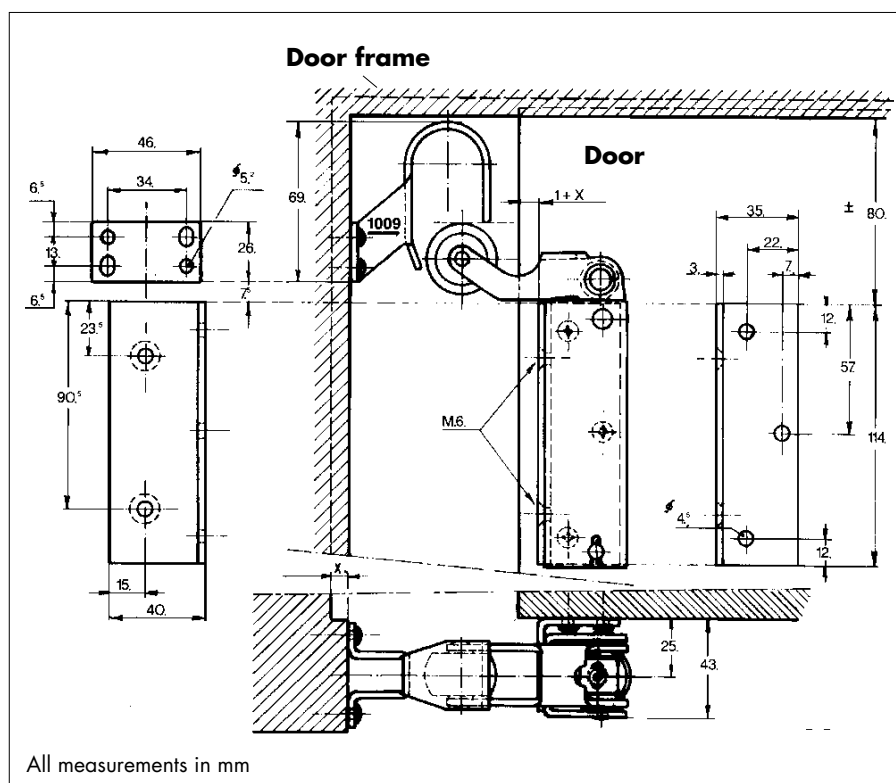

Mounting

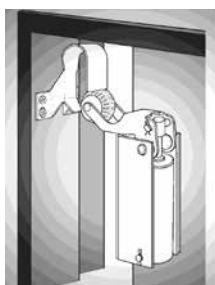

The mounting bracket is screwed onto the sliding door about 1 mm from the closing edge and about 80 mm below the upper edge of the door. Fix the cylinder with the two bolts to the casing and then screw the door damper to the mounting bracket with two M6-screws. To determine the position of the hook, push down the roller lever. The roller should pass just below the front edge of the hook. Only use the two oblong holes when fixing for the first time. The two remaining screws can be used once you have adjusted the hook to the optimal position.

Order Information

Z 1100 door check, 1009 hook, 20 N, nickel-plated	part no. 300367
Z 1100 door check, 1009 hook, 50 N, nickel-plated	part no. 300498
Z 1100 door check, 1009 hook, 80 N, nickel-plated	part no. 300499
each with a mounting bracket	