

C-538 SERIES BY-PASSING SLIDING DOOR KIT INSTRUCTION SHEET FOR 1-3/8" DOORS

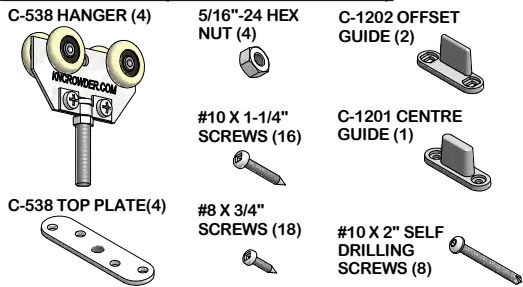

PARTS LIST (FOR 2 DOOR KIT)



EXTRUDED ALUMINUM TRACK

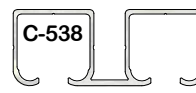

CDC-400 DOOR CATCH/STOP (4)

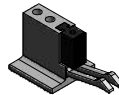

SPECIFICATIONS:

- LOAD CAPACITY: 125 LBS PER DR
- HEAVY-DUTY PRECISION BALL BEARING WHEELS WITH NYLON TIRE.
- FEATURES VERTICAL ADJUSTMENT BY THREADED TOP PLATE AND LOCK-NUT.
- IDEAL FOR MIRROR COVERED AND SOLID CORE DOORS.
- AVAILABLE IN 2 DOOR, 3 DOOR, AND 4 DOOR KITS.
- HANGERS ARE AVAILABLE IN STAINLESS STEEL (C-538-SS)

DIMENSION DETAILS:

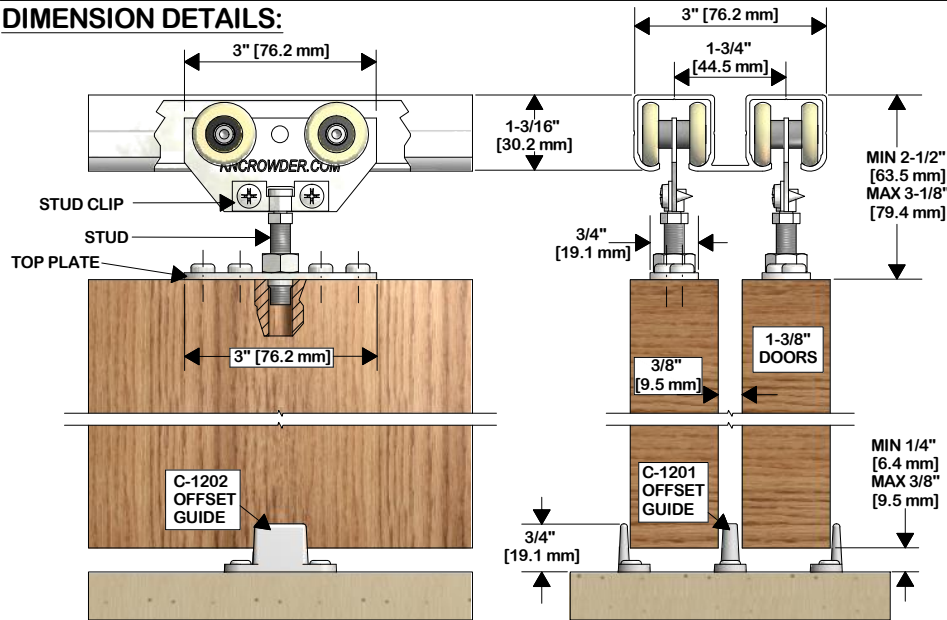

OPTIONAL PRODUCTS

GUIDE SYSTEM:

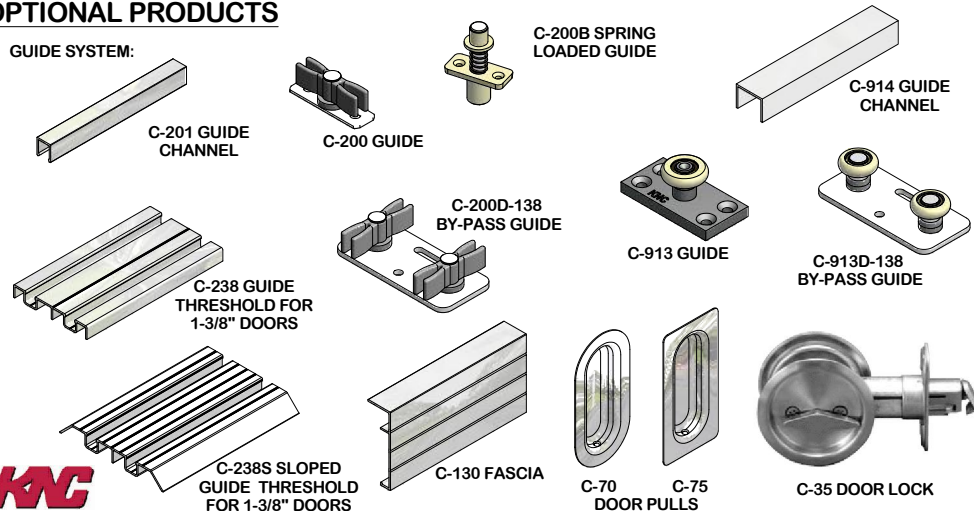

INSTALLATION INSTRUCTIONS

STEP 1

DETERMINE DOOR SIZE/HEADER HEIGHT BASED ON DIMENSIONS SHOWN IN DETAIL VIEWS AND CLEARANCE REQUIRED BELOW DOOR:

- MINIMUM OPENING HEIGHT (A) = DOOR HEIGHT + 2-3/4"
- MAXIMUM OPENING HEIGHT (A) = DOOR HEIGHT + 3-5/8"

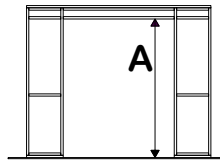

STEP 2

CUT TRACK TO LENGTH. TRACK LENGTH SHOULD BE EQUAL TO FINISHED OPENING SIZE LESS 1/8". INSERT C-538 HANGERS INTO TRACK AND SECURE TRACK TO HEADER WITH #8 X 3/4" SCREWS (6). NOTE: CLIP SCREWS MUST BE ACCESSIBLE AND FACE SAME SIDE OF OPENING (I.E. INSIDE OF CLOSET).

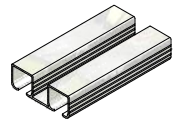

STEP 3

A) LOCATE CLEARANCE HOLE FOR HANGER STUD 3-1/2" FROM EACH EDGE OF DOOR. DRILL WITH 3/8" BIT AT LEAST 1-1/2" DEEP.

B) CENTER TOP PLATE OVER HOLE WITH FLAT SIDE UP, MARK SCREW HOLE LOCATIONS AND PRE-DRILL WITH 1/8" BIT AT LEAST 1" DEEP.

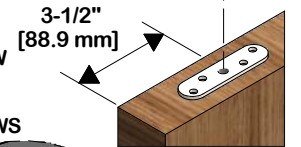

STEP 4

MOUNT TOP PLATES ON DOOR AND SECURE WITH #10 X 1-1/4" SCREWS (4 PER TOP PLATE).

STEP 5

USING A PHILLIPS SCREWDRIVER, REMOVE THE CLIP SCREWS ON HANGER TO REMOVE BOLT. PLACE ONE 5/16"-24 HEX NUT ON BOLT AND SCREW BOLT INTO TOP PLATE ON THE DOOR.

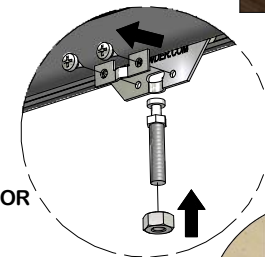

STEP 6

PREPARE DOOR FOR INSTALLATION OF OPTIONAL PRODUCTS SUCH AS GUIDE CHANNELS, CUP PULLS, DOOR LOCKS, ETC, AS REQUIRED. INDIVIDUAL INSTRUCTIONS ARE PROVIDED WITH THE RESPECTIVE PRODUCT.

STEP 7

LOCATE C-1201 CENTRE AND C-1202 OFFSET GUIDES AND SECURE TO FLOOR WITH #8 X 3/4" SCREWS (6). IT MAY BE NECESSARY TO INSTALL DOOR(S), DETERMINE GUIDE LOCATION, REMOVE DOOR(S) AND THEN SECURE GUIDES TO FLOOR. IF USING OPTIONAL C-201 OR C-914 GUIDE CHANNEL, INSTALL C-200 OR C-913 GUIDE IN PLACE OF THE C-1202 GUIDES. IF USING OPTIONAL C-238 GUIDE THRESHOLD, INSTALL C-200 GUIDES ON DOORS AND C-238 GUIDE THRESHOLD ON FLOOR.

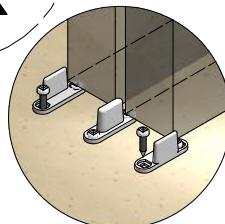

STEP 8

LOCATE DOOR UNDER HANGERS AND LIFT TO PLACE BOLTS INTO HANGER SLOT AND SECURE WITH THE CLIPS AND SCREWS PREVIOUSLY REMOVED IN STEP 5. DO NOT OVER TIGHTEN SCREWS.

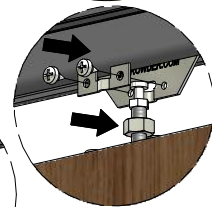

STEP 9

ADJUST DOOR HEIGHT AND PLUMB VIA HEX SECTION OF BOLT WITH 3/8" WRENCH. LOCK ADJUSTMENT BY TIGHTENING HEX NUT AGAINST TOP PLATE. RE-TIGHTEN CLIP SCREWS.

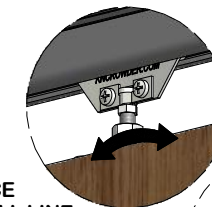

STEP 10

PLACE THE DOOR IN THE CLOSED POSITION, OR THE REQUIRED STOPPING LOCATION. MARK INSIDE TOP FACE OF TRACK IN LINE WITH THE EDGE OF HANGER. (THIS WILL LINE UP TO THE FRONT OF THE NEOPRENE BUMPER ON THE CDC-400. PLACE CDC-400 DOOR CATCH/STOP AT REQUIRED LOCATION AND SECURE TO TRACK/HEADER WITH #10 X 2" SELF DRILLING SCREWS WITH A ROBERTSON DRIVER BIT. CHECK PLACEMENT BY PLACING THE DOOR AGAINST THE STOP, RE-POSITION IF REQUIRED & SECURE FINAL POSITION WITH BOTH SCREWS.

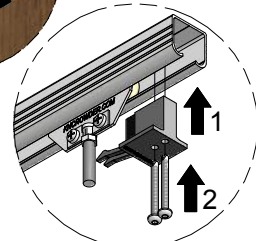

K.N. CROWDER MFG. INC.
1220 BURL OAK DRIVE
BURLINGTON, ONTARIO, CANADA, L7L 6B3
TELEPHONE: 905-315-9788
TOLL FREE PHONE: 1-866-999-1KNC (1562)
FAX: 905-315-8090 - TOLL FREE FAX: 1-800-567-0123
WEBSITE: www.kncrowder.com -- E-MAIL: customerservice@kncrowder.com

K.N. CROWDER INC.
210 EIGHTH STREET SOUTH
LEWISTON, NEW YORK, U.S.A. 14092
TELEPHONE: 1-716-754-8247
TOLL FREE FAX: 1-800-567-0123