

C-350/C-600 SERIES SLIDING DOOR KIT INSTRUCTION SHEET FOR 3/4" TO 1-3/8" DOORS



PARTS LIST (FOR 1 DOOR KIT)



(*ALL PARTS FOR C-600 KIT ARE 2X QUANTITY OF C-350 KIT)

SPECIFICATIONS:

- LOAD CAPACITY: 75 LBS PER DOOR.
- CAN BE MOUNTED SIDE BY SIDE FOR BY-PASS APPLICATIONS
- 3 NYLON WHEELS PER HANGER.
- FEATURES VERTICAL ADJUSTMENT BY THREADED TOP PLATE AND LOCK-NUT.

INSTALLATION INSTRUCTIONS

STEP 1

DETERMINE DOOR SIZE/HEADER HEIGHT BASED ON DIMENSIONS SHOWN IN DETAIL VIEWS AND CLEARANCE REQUIRED BELOW DOOR:
 -MINIMUM OPENING HEIGHT (A) = DOOR HEIGHT + 2-5/8"
 -MAXIMUM OPENING HEIGHT (A) = DOOR HEIGHT + 3-1/2"

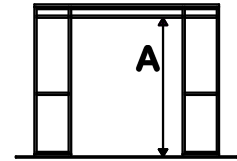

STEP 2

CUT TRACK TO LENGTH. TRACK LENGTH SHOULD BE EQUAL TO FINISHED OPENING SIZE LESS 1/8". INSERT C-350 HANGERS INTO TRACK AND SECURE TRACK TO HEADER WITH #8 X 3/4" SCREWS (6)*. **NOTE: CLIP SCREWS MUST BE ACCESSIBLE AND FACE SAME SIDE OF OPENING (I.E. INSIDE OF CLOSET).**

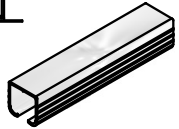

STEP 3

A) LOCATE CLEARANCE HOLE FOR HANGER STUD 3-1/2" FROM EACH EDGE OF DOOR. DRILL WITH 3/8" BIT AT LEAST 1-1/2" DEEP. B) CENTER TOP PLATE OVER HOLE WITH FLAT SIDE UP, MARK SCREW HOLE LOCATIONS AND PRE-DRILL WITH 1/8" BIT AT LEAST 1" DEEP.

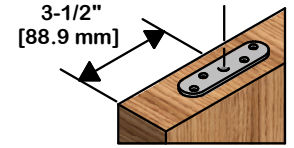

STEP 4

MOUNT TOP PLATES ON DOOR AND SECURE WITH #10 X 1-1/4" SCREWS (4 PER TOP PLATE).

STEP 5

USING A PHILLIPS SCREWDRIVER, REMOVE THE CLIP SCREWS ON HANGER TO REMOVE BOLT. PLACE ONE 5/16"-24 HEX NUT ON BOLT AND SCREW BOLT INTO TOP PLATE ON THE DOOR.

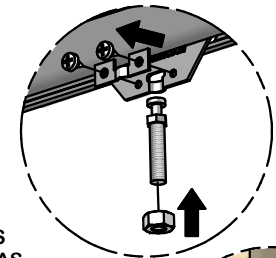

STEP 6

PREPARE DOOR FOR INSTALLATION OF OPTIONAL PRODUCTS SUCH AS GUIDE CHANNELS, CUP PULLS, DOOR LOCKS, ETC., AS REQUIRED. INDIVIDUAL INSTRUCTIONS ARE PROVIDED WITH THE RESPECTIVE PRODUCT.

STEP 7

LOCATE C-1202 GUIDES AND SECURE TO FLOOR WITH #8 X 3/4" SCREWS (4). IT MAY BE NECESSARY TO INSTALL DOOR, DETERMINE GUIDE LOCATION, REMOVE DOOR AND THEN SECURE GUIDES TO FLOOR. IF USING OPTIONAL C-201 GUIDE CHANNEL, INSTALL C-200 GUIDE IN PLACE OF THE C-1202 GUIDES. IF USING C-600 SERIES AND C-238 GUIDE THRESHOLD, INSTALL IN PLACE OF C-1201 AND C-1202 GUIDES.

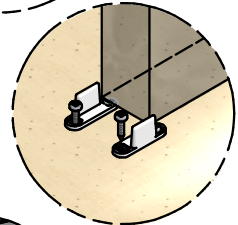

STEP 8

LOCATE DOOR UNDER HANGERS AND LIFT TO PLACE BOLTS INTO HANGER SLOT AND SECURE WITH THE CLIPS AND SCREWS PREVIOUSLY REMOVED IN STEP 5. DO NOT OVER TIGHTEN SCREWS.

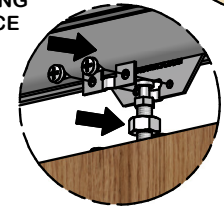

STEP 9

ADJUST DOOR HEIGHT AND PLUMB VIA HEX SECTION OF BOLT WITH 3/8" WRENCH. LOCK ADJUSTMENT BY TIGHTENING HEX NUT AGAINST TOP PLATE. RE-TIGHTEN CLIP SCREWS.

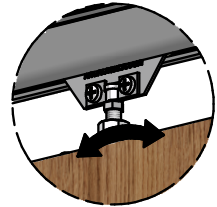

STEP 10

IF USING OPTIONAL C-100 DOOR STOP, INSTALL IN TRACK AT DESIRED LOCATION.

DIMENSION DETAILS:

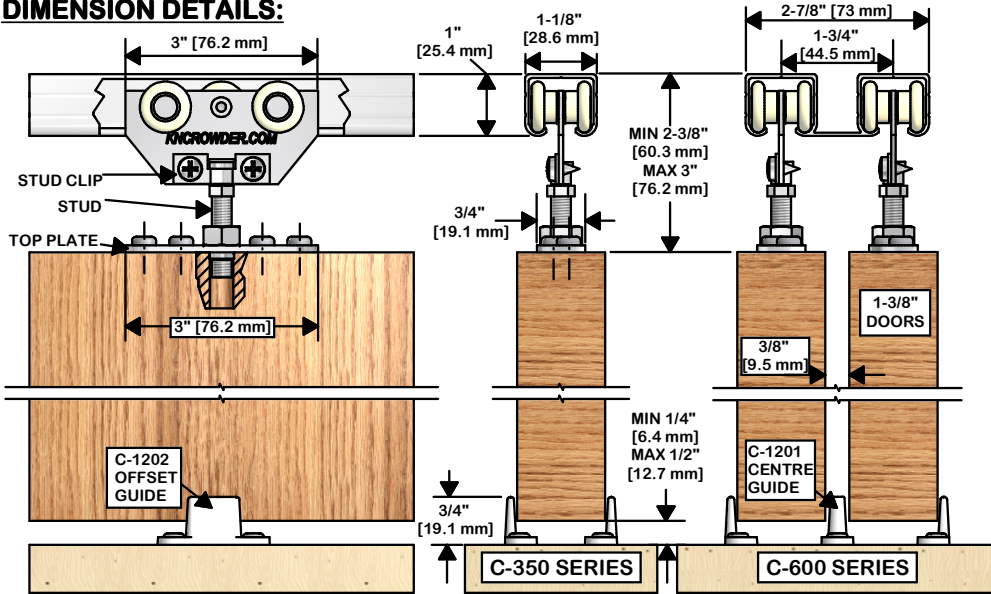

OPTIONAL PRODUCTS

GUIDE SYSTEM:

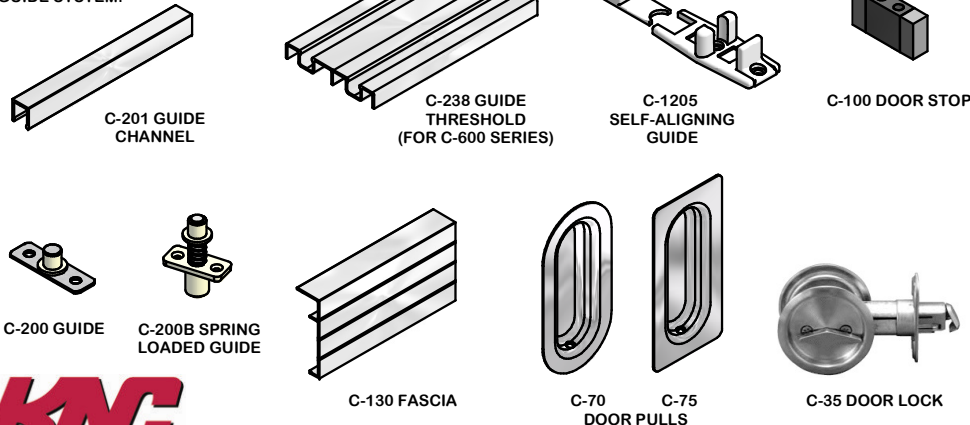

K.N. CROWDER MFG. INC.
 1220 BURLOAK DRIVE
 BURLINGTON, ONTARIO, CANADA, L7L 6B3
 TELEPHONE: 905-315-9788 - FAX: 905-315-8090
 TOLL FREE FAX: 1-800-567-0123

K.N. CROWDER INC.
 210 EIGHTH STREET SOUTH
 LEWISTON, NEW YORK, U.S.A. 14092
 TOLL FREE TELEPHONE: 1-866-999-1KNC (1562)
 TOLL FREE FAX: 1-800-567-0123

WEBSITE: www.kncrowder.com -- E-MAIL: customerservice@kncrowder.com